

This operation manual

should be read through carefully **before** you connect LR101 for the first time and put it into operation. The manual helps you recognize the inter-dependencies in the feedback chain in Digital plus, and so saves you possible problems.

**READ FIRST -
THEN PROGRAM ADDRESS AND SETTINGS –
THEN INSTALL!**

LR101 Feedback Module

Art. Nr. 11 201
1st edition, 06 99

Digital

plus
by Lenz TM

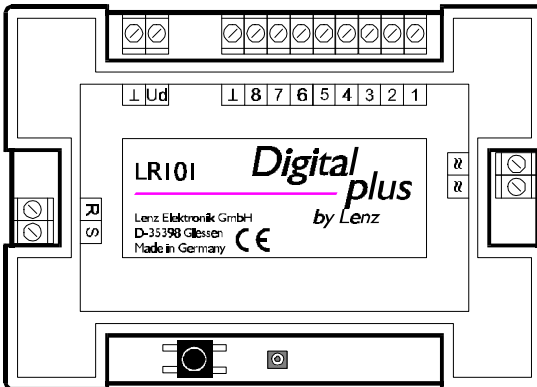

What is feedback information used for?

The most well known and commonly used form of feedback is information as to if a track on your model train layout is occupied or not. Even when you control your layout “only” by hand, you will surely want to know the status of tracks that can’t be seen. Hidden staging yards are referred to as “hidden” for a reason.

Feedback is absolutely necessary for fully or partially automated operation. How else will a tower cab LW100 or a computer program “see” if a particular track is free or not? This information is needed in order to know if a train may enter a particular track or not.

General information on occupancy reporting in model

Normally occupancy status of tracks is detected by using an electronic circuit to measure the current flowing through a track section. Any current user on the track section generates such a current flow. “Current flowing” is therefore the same as the track is “occupied”; “no current flowing” means the track is “free”. The occupancy detector is therefore in a technical sense a current detector.

In case the track voltage disappears (in digital operation there is normally a constant voltage on the track), no more current flows, and an occupancy feedback is thereby no longer possible. A loss of track voltage can be caused by turning off the power supply or by a short circuit. In this case, the feedback output will send “free”, even though the track is actually occupied.

Occupancy detectors that use a helper voltage to bridge the loss of track voltage are unsuited for digital operation. This helper voltage usually causes problems, since locomotive decoders may interpret it erroneously. These types of occupancy detectors also need their own, separate power supply which means higher costs and more wiring.

The special features of the new Digital plus feedback concept

In the Digital plus feedback concept three components are combined to provide feedback on the status of the layout: Feedback encoder LR101, occupancy (current) detector LB100 and voltage monitor LB050.

The feedback encoder LR101 not only evaluates information from LB100s, but also information from one or more voltage monitors LB050s. If the LR101 determines, via its connection to an LB050, that voltage to the track is lost, it “freezes” the last feedback status. A sample diagram illustrating the wiring of a track block follows.

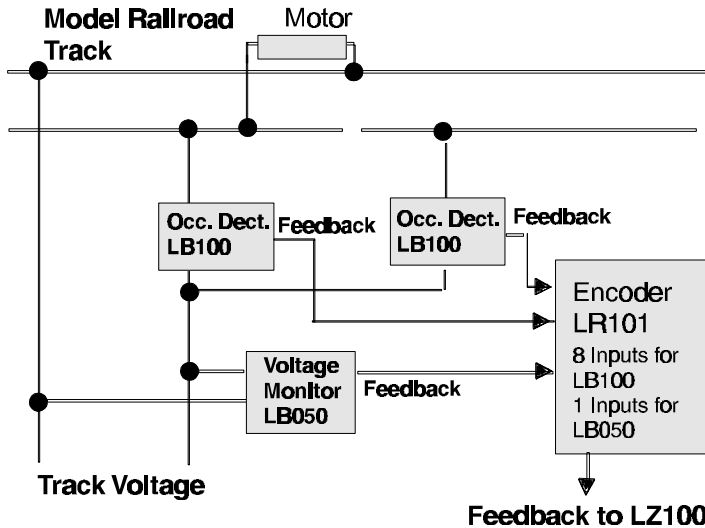

A locomotive on the track is current user. Since current flows, the LB100 sends out the information “occupied” to the LR101. If for any reason power to the track is lost, no current will flow and the LB100 will report “free”, even though that does not correspond to the actual status. However, in this example, the LR101 can use the connected voltage monitor LB050 to determine that there is no power to the track. It therefore “knows” that it must not pass the incorrect “free” information from the LB100 on to the command station.

The careful combination of LR101s and LB050s prevents a loss of power or a short circuit from causing erroneous free feedback to be sent to the command station.

The command station polls all connected feedback encoders LR101/100 in turn. This takes about 30 milliseconds. This polling is responded to only by any LR101/100 that has had a change in status on the inputs. The information for 4 inputs at a time is sent, which requires a time of approximately 2 milliseconds. This time adds to the polling cycle. If several LR101/100 report, then the total length of the polling cycle in milliseconds can be calculated as follows:

$$30 \times (\text{the number of LR101/100 reporting} \times 2)$$

If you are already using LR100s

LR100s can be used together with the new LR101s. Please take care to divide up the addresses correctly, and note that LR100 uses two feedback addresses, while LR101 uses only one.

Specifications of LR101

The LR101 has 8 feedback inputs and one input for a voltage monitor. On each feedback inputs you can connect an occupancy detector LB100 or any other potential free (isolated) contact (such a reed switches or relays). A potential free contact is a type of switch that creates no current connections from the layout or other components of the Digital plus system to the LR101.

The input for voltage monitoring is designed solely for connecting with the voltage monitor LB050.

Operation mode of the feedback inputs

The microprocessor in the LR101 checks the inputs in a cyclical manner. If during that checking a connection between one of the feedback inputs and the \perp terminal is found, or a previously existing connection is broken, the LR101 sends this information on to the command station LZ100 during the next polling cycle. An LB100 occupancy detector connected to the feedback inputs generates such a connection when the track is occupied (current flows, see above) and clears this connection when the track is not occupied.

All 8 feedback inputs have the capability to have a programmable delay time. This works as follows:

If a connection between one of the feedback inputs and the \perp terminal is detected, it is reported to the command station immediately after the connection happens.

If an existing connection is broken, then this is only reported to the command station after the programmed delay time has expired.

Example:

An occupancy detector LB100 monitors a track section. If a locomotive enters this track section, then the “occupied” status is immediately transmitted to the command station. If the locomotive then leaves the track section, the programmed delay time will pass before a “free” status is transmitted to the command station.

If during the delay time before the LR101 reports “free”, an “occupied” is again detected, then no feedback is sent, and the delay time will start again. Only when “free” is detected, **and** the delay time has fully expired, will the “free” status be transmitted to the command station. This mode of operation has the advantage that very short interruptions in the power supply to a locomotive, for example through poor contact between wheel and track, will not immediately lead to the track section being reported as “free”.

This delay time can be programmed in a range from 10 msec to 2.55 sec, in increments of 10 msec.

Function of the input for voltage monitor

Only a voltage monitor LB050 may be connected to this input. As the feedback inputs, the input is cyclically checked by the microprocessor. If a connection between the \perp terminal and terminal **Ud** is detected, then no feedback is passed on to the command station (see above in the Digital plus feedback concept). The voltage monitor LB050 creates this connection when no digital voltage is present at the track.

Push button and LED

The push button is used to program the address during operation and to restore factory default settings. The LED serves as a display during these operations. It will also light up briefly whenever a transmission to the command station takes place.

Address range

The address range for feedback in the Digital plus System is **1 - 128**. The addresses must not be assigned more than once, since that prevents unambiguous feedback.

The address range for feedback is divided into two groups: Feedback addresses 1 to 64 can be used both for storing turnout positions for accessory decoders LS100s, as well as for storing information from feedback encoders LR101/100. There must not be any duplicate use of addresses.

To prevent this, you must take into account the following special circumstance: A group of 4 turnout addresses uses one feedback address:

Turnout addresses	occupy feedback address
1 to 4	1
5 to 8	2
9 to 12	3

The complete table of corresponding addresses can be found at the end of this manual.

The following example is used to explain this concept:

Let's assume that you have installed 2 accessory decoders LS... on your model train layout. 4 turnouts are connected to each accessory decoder. The turnout addresses 1-8 are selected. Those 8 turnout addresses also occupy feedback addresses 1 and 2, according to the table above. These may then not be used for feedback encoders LR101/100.

If you now want to install a feedback encoder LR101, then it must therefore not be programmed to addresses 1 or 2, but must be programmed to the next free address, 3.

If you now want to add on to your layout, and additional turnouts are installed, then you may want to number them consecutively. But then you would not be able to use addresses 9-12, since the feedback address 3 is already being used by your LR101. Therefore please note

Our suggestion for assigning addresses:

Start with address 65 for feedback encoder LR101/100. This feedback address is beyond the range that can also be used by

accessory decoders. Then you can add on to your layout and ensure consecutive numbering of your turnouts from 1 to 256, without having to leave out certain addresses.

Address 65 is programmed into your LR101 as the factory default at delivery.

Programming address and other settings of LR101

Before you install an LR101 on your layout, you must set it to its address; we also refer to that as programming.

The settings are stored permanently inside the LR101 and the data is not lost even when the Digital plus system is turned off. The values of the settings are stored in so called configuration variables (CV). You can think of these CVs as index cards in a card catalog, where you enter values on the cards and can then erase them again and write in new values.

You can change these index cards by connecting the LR101 to the programming output of the LZ100 command station. Using the LH100 hand held you can read out values and enter new ones.

Factory default settings for the CVs:

CV	Meaning	Value	CV	Meaning	Value
1	Address	65	13	Delay input 3	50
7	Version number	10	14	Delay input 4	50
8	Manufacturer ID	99	15	Delay input 5	50
11	Delay input 1	50	16	Delay input 6	50
12	Delay input 2	50	17	Delay input 7	50
			18	Delay input 8	50

CVs other than those listed above are not supported.

Programming the address

You can choose between 2 different approaches:

1. Using the programming output on the command station LZ100 using an LH100. This approach can be used before installation of the LR101. This technique can also be used to change the settings of the inputs.
2. Programming during operation. This approach can be used whenever you have already installed the LR101. This approach you can only be used to change the address.

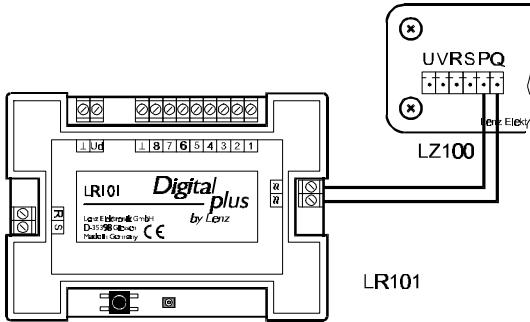

Illustration 1

Programming the address at the programming output

To do this you need a command station and hand held controller LH100. At this point we assume that these units are correctly connected with each other, and in operation.

Connect one of the ≈ terminals with terminal **P** and the other terminal ≈ with terminal **Q** on the LZ100. See illustration 1:

Now proceed as follows (the following description assumes a hand held controller LZ100 with software version 2.1 and a command station with software version 2 or greater):

Press	On the display you see
F	FUNC* _
8	PROG*
Enter	OFF

In the display you will now see the most recently chosen programming mode. This is most often programming using CVs.

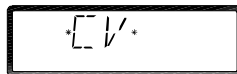

Other possibilities are:



Programming using registers)



(Programming in page mode)

If the CV programming mode is not displayed, then press the “+” key repeatedly until “CV” is displayed. By pressing the “Enter” key, you select this mode.

In the display you now see “Search”:



The command station is reading decoders connected to the programming output. With LR101 this operation ends with an error message:

"ERR02"

Ignore this error message and continue:

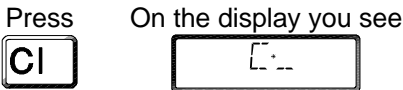

Now enter the number of the CV that is “responsible” for the address, that is number 1.

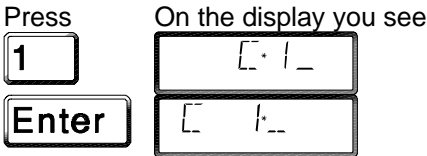

You can now either key in the desired address, or first read out the address that is already stored.

If you want to read out, then don't key in a number, but just press “Enter”. The reading process takes a short while, during which time the lower row will show a “L”. When the reading process is over, the address read is displayed. From the factory you will here read out address 65. If you now want to enter another address, then clear the display with the “CI” key.

If you want to enter an address, simply key in the desired address and start the programming sequence with “Enter”.

Pay attention to the valid address range! If you exceed this range, programming will not take place, the original value will be kept and LH100 will display “ERR02”.

Setting the address during operation

To do this you use the push button and the small LED next to it.

This method is best used when you have already installed the LR101 on your layout and you now want to change its address. The LR101 does not need to be connected to a programming track to perform this operation.

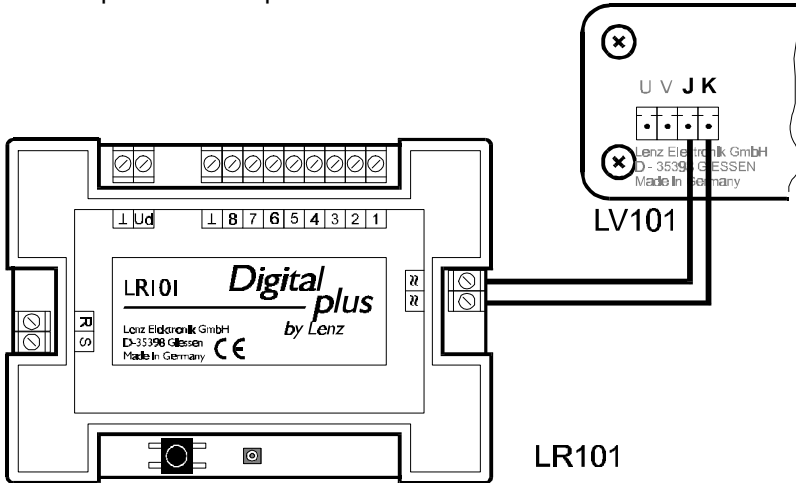

Illustration 2

If your LR101 is already connected to **J** and **K** on a power station, you can program it to another address using the following steps. If you supply power to the LR101 from a separate AC source, then you must remove this connection and make a connection to terminals **J** and **K** on a power station (LV090, LV100, LV101 or LV200) for writing the address. See illustration 2.

Make certain that your system is not in “Emergency off” or “Emergency Stop”.

On hand held controller LH100 select the turnout throwing mode, key sequence F, 5. Enter the address that you want to program the LR101 to as the turnout address. If you already have an accessory decoder programmed to that address it does not matter for this operation!

Now press down the button on the LR101 and hold it pressed until the LED lights up.

On LH100 now press either the “+” or “-” key. This sends out a switching command, containing the address. This address is received by LR101 too (it is connected to the same wires as the accessory decoders) and is stored in CV1.

When this procedure is complete, the LED turns off again.

If you selected a turnout address that is outside the allowed LR100 range, then there is no new address entered, the old address remains unchanged. To indicate this, the LED flashes rapidly.

Programming delay times

This programming must be done at the programming output of command station LZ100 using LH100. The procedure is the same as described under “Programming the address”, however instead of selecting CV1 for the address, use CV11 to CV18, depending on which input you want to change.

Then enter the value for the desired delay time (see below) and start the programming sequence with “Enter”.

The delay time can be programmed in a range from 0.01 sec (10 msec) to 2.55 sec (2550 msec) in increments of 0.01 sec (10 msec).

The valid range of values is 1-255. Programming the value 0 can lead to no feedback being provided from this input.

If you want a particular delay time and want to know the value to program, use this formula:

$$\text{Delay in seconds} \times 100 = \text{Value for CV}$$

If you want to know the amount of delay a programmed value corresponds to, use this formula:

$$\text{Value in CV} / 100 = \text{Delay in seconds}$$

The factory default setting for CV11 to 18 is 50, which corresponds to a delay of 0.5 sec.

Restoring the factory default settings

You can restore these settings anytime during operation of your Digital plus system, while the LR101 is connected (regardless of via separate power supply or **J** and **K**).

Press the button on the LR101 and hold it depressed until the following sequence is over:

After 5 seconds the LED lights up. In another 5 seconds the LED starts to flash. Keep the button pressed until the flashing stops and the LED turns off again. The factory default settings of the LR101 have now been restored.

Connecting the LR101

You can supply power to the LR101 either from digital voltage from the track (terminals **J** and **K** of a power station LV090, LV100, LV101 or LV200) or from an AC power supply (12-16V AC).

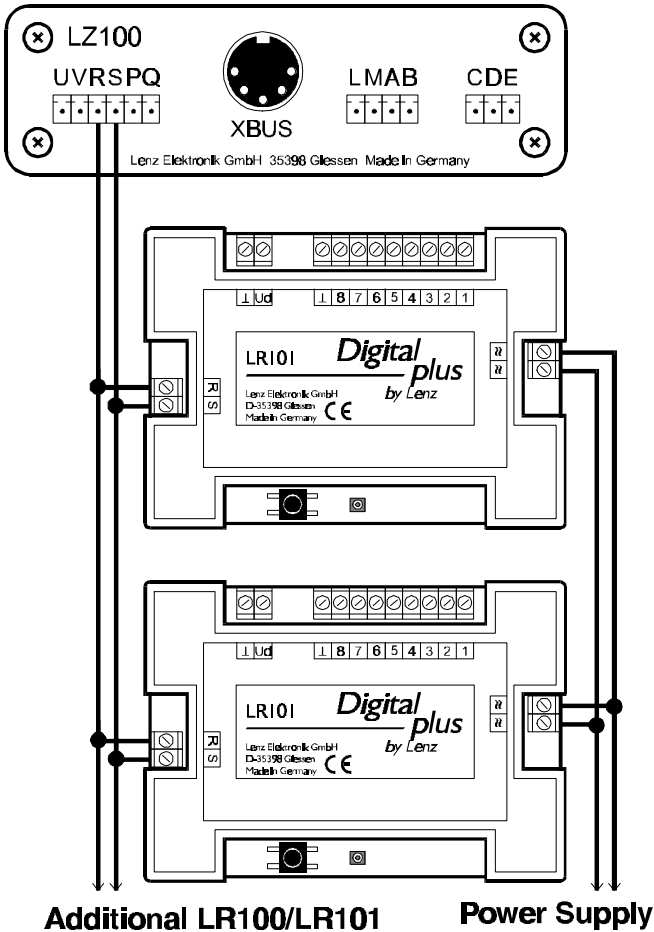

Illustration 3

Terminals **R** and **S** are the connections for the feedback bus. These terminals are connected to the corresponding terminals on LZ100. Additional LR101/100s are simply connected in parallel. See illustration 3.

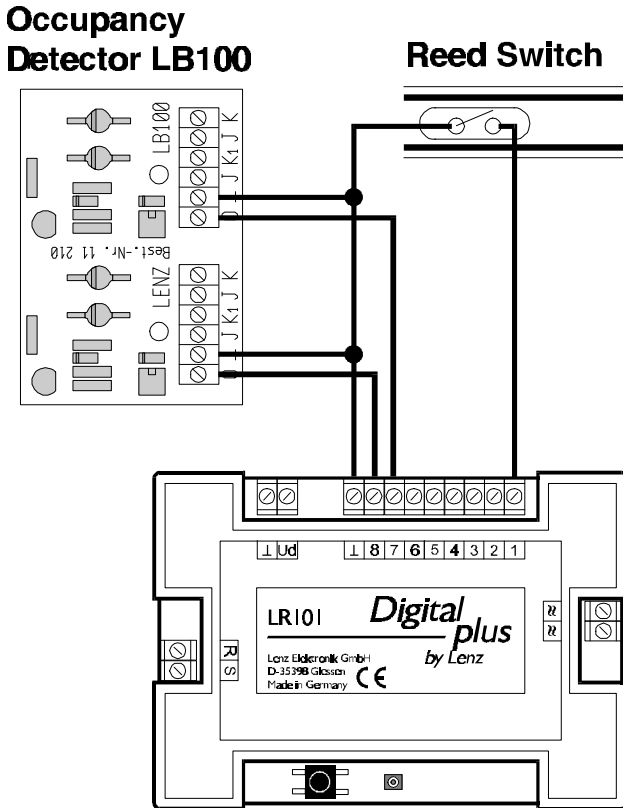

Illustration 4

Any potential free contact can be connected to the input of the LR101. Please see illustration 4 for an example of connecting the LB100 feedback devices and a potential free read switch.

In illustration 4 we have only included the connections between the LR101 and the feedback originators, in order to keep the diagram simple. All other wiring was not drawn, but must of course be present for the device to function. For a complete connection diagram of LB100, please refer to the LB100 manual.

Warning:

Track contacts that generate connections to the track voltage must not be used! They will lead to the destruction of the LR101!









Temporary connection of LR101 for testing

In the following example we will show you how the display on hand held controller LH100 changes when you change status of the feedback inputs of an LR101. All of the steps in the following section require the use of a hand held controller with software version 1.5 or higher. Please ensure that your hand held controller has the right software version (key sequence F, 9 , 9).

For this example we will use the wiring as shown in illustration 5. Please note that in illustration 5 the necessary connections between command station and power station are left out to keep the illustration clear. We assume that you have made those connections before you follow this example.

In the following example, the LR101 is programmed to address 39.

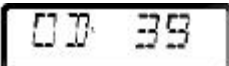
Carry out the following steps on LH100:

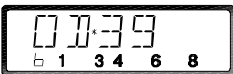
Press	On the display you see
	
	
	
	
	

Since the momentary switch button in illustration 5 is open, none of the feedback inputs are displayed. If this button is now pushed (closed), then you get the following display on the LH100:

Monetary switch is On the display you see

open

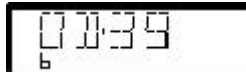

closed



If you programmed in a delay for input 1, then you can readily see this delay on the LH100 between the time the switch is opened and the time the display changes.

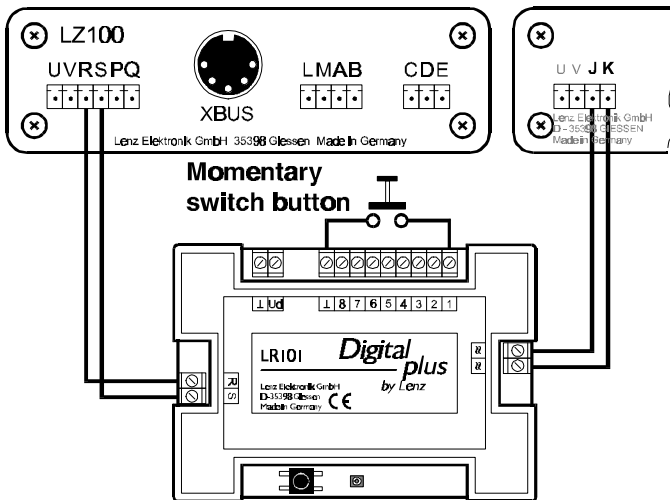

Illustration 5

The function “Read out feedback” of LH100 is also well suited to test the correct wiring and programming of the LR101.

Table of feedback addresses and turnout addresses:
 F=feedback address, T=turnout addresses

F	T	F	T	F	T
1	1 to 4	23	89 to 92	44	173 to 176
2	5 to 8	24	93 to 96	45	177 to 180
3	9 to 12	25	97 to 100	46	181 to 184
4	13 to 16	26	101 to 104	47	185 to 188
5	17 to 20	27	105 to 108	48	189 to 192
6	21 to 24	28	109 to 112	49	193 to 196
7	25 to 28	29	113 to 116	50	197 to 200
8	29 to 32	30	117 to 120	51	201 to 204

F	T	F	T	F	T
9	33 to 36	31	121 to 124	52	205 to 208
10	37 to 40	32	125 to 128	53	209 to 212
11	41 to 44	33	129 to 132	54	213 to 216
12	45 to 48	34	133 to 136	55	217 to 220
13	49 to 52	35	137 to 140	56	221 to 224
14	53 to 56	36	141 to 144	57	225 to 228
15	57 to 60	37	145 to 148	58	229 to 232
16	61 to 64	38	149 to 152	59	233 to 236
17	65 to 68	39	153 to 156	60	237 to 240
18	69 to 72	40	157 to 160	61	241 to 244
19	73 to 76	41	161 to 164	62	245 to 248
20	77 to 80	42	165 to 168	63	249 to 252
21	81 to 84	43	169 to 172	64	253 to 256
22	85 to 88				

Caution

Not suited for children under 3 years of age because of small parts that may be swallowed. If used carelessly, injury may result due to functionally required sharp edges and points! Suited only for dry rooms. Reservation for error, as well as for changes due to technical improvements, product development or other production methods. Any responsibility for damage or incidental damages due to non-intended use, non-compliance with this manual, operation with transformers not intended for model railroads, altered or damaged transformers, or other electrical devices, unauthorized changes, acts of violence, overheating, moisture damage, etc. is excluded; this also voids the warranty.

Hüttenbergstraße 29
35398 Gießen, Germany
Hotline: 06403 900 133
Fax: 06403 5332
<http://www.lenz.com>



Lenz Agency of North America
PO Box 143
Chelmsford, MA 01824
ph/fax: 978 250 1494
support@lenz.com

This equipment complies with Part 15 of FCC Rules. Operation is subject to the following two conditions: (1) this device may not cause harmful interference, and (2) this device must accept any interference received, including interference that may cause undesired operation.

€ Please save this manual for future reference!

© 1999 Lenz GmbH, All Rights Reserved