

31

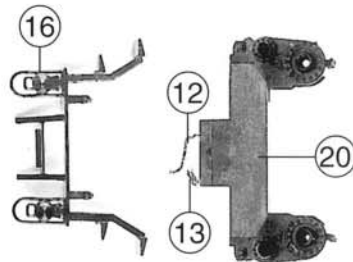

25 o. Abb. / no ill.
Schiebereinsatz
Slide insert

26 o. Abb. / no ill.
Zylinderschutzrohr
Protection tube

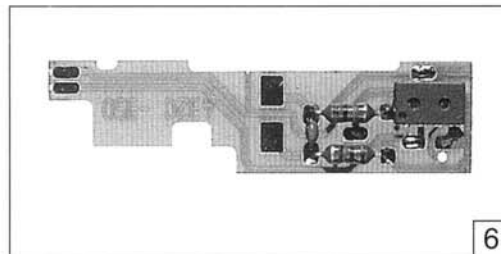
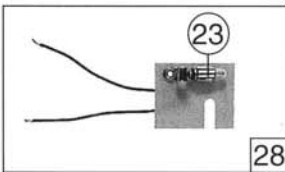
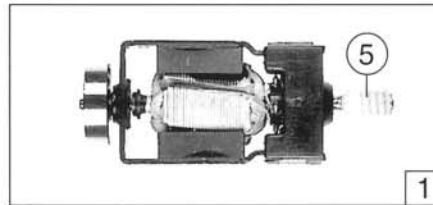
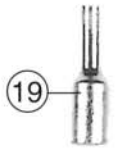
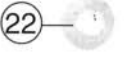
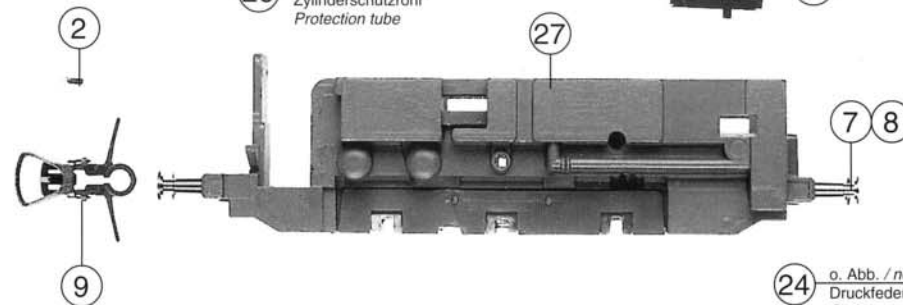

24 o. Abb. / no ill.
Druckfeder
Spring



Roc. Nr.	Text	Art.-Nr.	Preis-gruppe
1	Motor Motor	85110	57
2	Schraube M 1,6 x 5 Screw M 1,6 x 5	85702	3
3	Zahnrad z=14r; m 0,4 Gear T=14r; m 0,4	86403	2
4	Zahnrad z=17i; m 0,4 Gear T=17i; m 0,4	86408	2
5	Schnecke m 0,4 Worm m 0,4	86713	5
6	Platine komplett Printed circuit assembly	87831	42
7	Puffer gewölbt Buffer vaulted	88504	4
8	Puffer flach Buffer flat	88505	4
9	Kupplung Coupling	89203	5
10	Achse 2,6 x 9,3 Axle 2,6 x 9,3	89700	2
11	Achse 2,6 x 11,5 Axle 2,6 x 11,5	89701	2
12	Seuthe Kontakt 1 Seuthe contact 1	89974	4
13	Seuthe Kontakt 2 Seuthe contact 2	89975	4
14	Hebel links Lever left	91075	2
15	Hebel rechts Lever right	91076	2
16	Laternensatz Lanterne	95080	8
17	Dachlüfter Roof vent	95082	2
18	Motorspanne Motor clamp	106663	3
19	Dampfentwickler Boiler	106664	35
20	Zylinderblock Cylinder block	106653	20
21	Seuthehalter Seuthe support	106912	5
22	Filzscheibe Felt slice	106913	2
23	Glühlampe 16 V Light bulb 16 V	109088	12
24	Druckfeder Spring	86209	2
25	Schiebereinsatz Slide insert	107249	2
26	Zylinderschutzrohr Protection tube	107250	2
27	Grundrahmen Loco frame	108973	20
28	Lampenplatine Bulb board assembly	108974	29
29	Lichtleitersatz Glazing set	108975	8
30	Lichtabdeckung Light cover	108976	3
31	Gehäuse Betr.Nr. 80 017 Body Betr.No. 80 017	109231	46