

# Original ROCO-Ersatzteile Original ROCO Replacement Parts

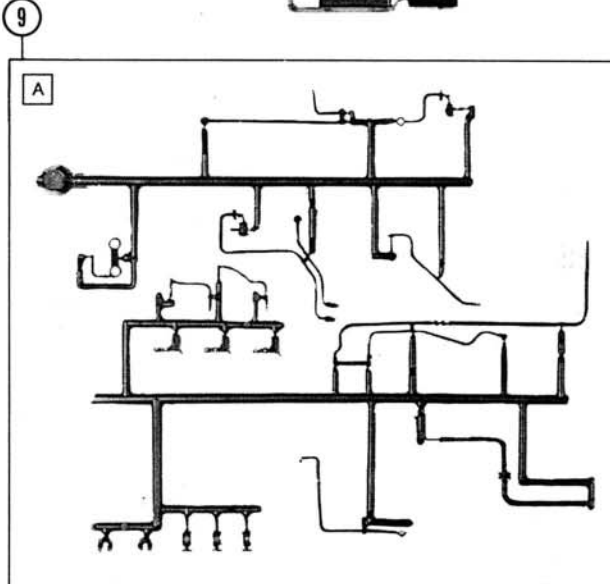

74  
 130  
 96  
 KPEV T 12

43271  
 43272  
 43273  
 (43025)

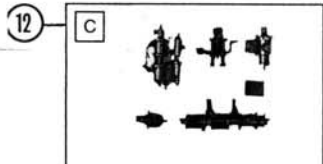
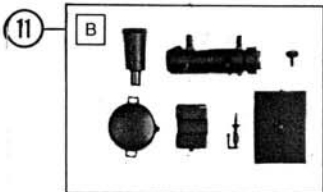
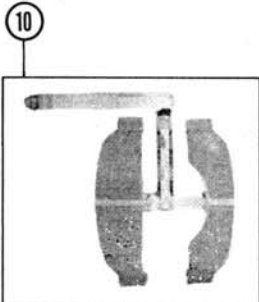
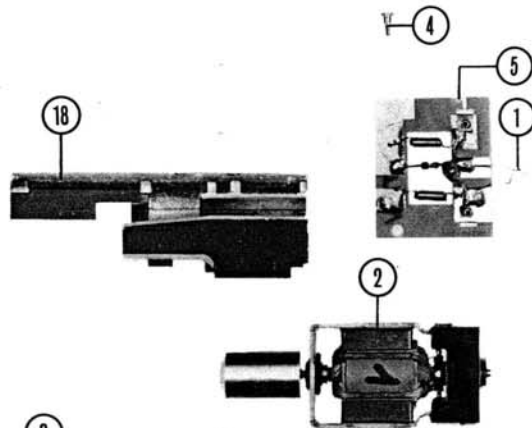
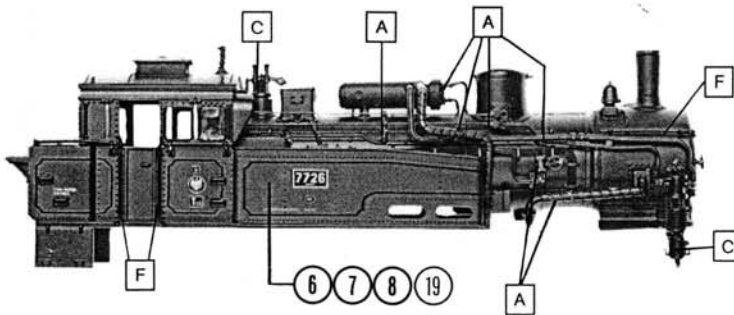
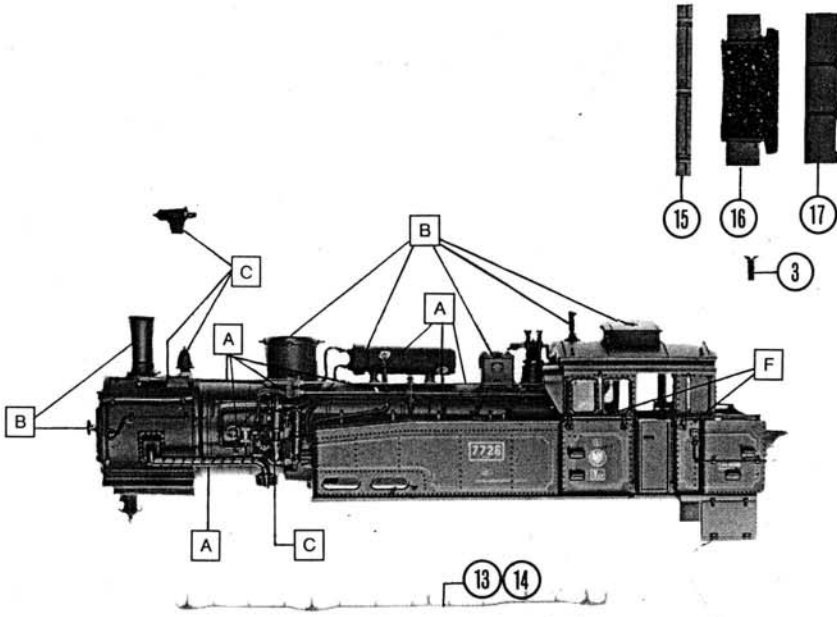

St. Nr.	Art.-Nr. neu	Art.-Nr. alt	Text	Preis-gruppe
1	10025	2586 S	Drahtlampe Lead bulb	—
2	85044	—	Motor mit Schwungrad Motor with flywheel	—
3	85714	81011 B-25G	Senkkopfschraube M2 x 4 Screw M2 x 4	2
4	85801	4112 S-134	Schraube M1,4 Screw M1,4	2
5	87612	—	Platine Printed circuit	36
6	95380	—	Gehäuse kpl. für 43271 Body assembly for 43271	73
7	95381	—	Gehäuse kpl. für 43025 Body assembly for 43025	74
8	95382	—	Gehäuse kpl. für 43272 Body assembly for 43272	74
9	95383	—	Teile-Satz A Parts-set A	30
10	95384	—	Teile-Satz A Parts-set A	18
11	95385	—	Teile-Satz B Parts-set B	20
12	95386	—	Teile-Satz C Parts-set C	20
13	95387	—	Leitung für 43271 Pipe for 43271	3
14	95388	—	Leitung für 43272 Pipe for 43272	3
15	95389	—	Kohlenkasten Coal chest	3
16	95390	—	Kohlenimitation Coal-imitation	5
17	95391	—	Deckel Cover	5
18	95428	—	Gewicht Weight	25
19	95430	—	Gehäuse kpl. für 43273 Body assembly for 43273	74

Text für Blatt 110/2

19	10021	4572 S	Glühlampe Light bulb	—
20	40243	4612 S	Kupplung Coupling	—
21	85604	4689 S	Haltring Half ring	—
22	85670	81000 B-250	Traktionsfelge Screw M2 x 4	2
23	85672	81000 B-252	Schraube M2 x 6 Screw M2 x 6	2
24	85674	81000 B-254	Schraube M2 x 8 Screw M2 x 8	2
25	85678	81000 B-260	Schraube M2 x 16 Screw M2 x 16	2
26	85715	81011 B-157	Senkkopfschraube M2 x 5 Countersunk screw M2 x 5	2
27	85801	4112 S-134	Schraube M1,4 lang Screw M1,4 long	2
28	85802	4112 S-135	Schraube M1,4 kurz Screw M1,4 short	2
29	85803	4112 S-136	Schraube M1 Screw M1	2
30	86100	4115 S-120	Distanzhülse Distance tube	5
31	86202	4149 S-066	Feder Spring	2
32	86208	14143 S-011	Zugfeder Tensile spring	2
33	86404	4151 B-003	Zahnrad z 14; m 0,4 Gear T 14; m 0,4	2
34	86405	4151 B-004	Zahnrad z 17; m 0,4 Gear T 17; m 0,4	2
35	86422	4122 S-110	Zahnrad z 17; m 0,4 Gear T 17; m 0,4	2
36	86423	4114 S-025	Achszahnrad z 23; m 0,4 Axle gear T 23; m 0,4	2
37	86701	4151 B-001	Schnecke m 0,4 Worm m 0,4	5
38	86811	—	Schneckensatz Worm set	24
39	87020	—	Siliconkardan Siliconcardan	5
40	87613	—	Platine für Stirnbeleuchtung Head lamp-printed circuit	30
41	87614	—	Radkontakt-Platine Wheel current contact-printed circuit	35
42	88504	4114 S-400	Buffer gewölbt Buffer vaulted	4
43	88505	4114 S-401	Buffer flach Buffer flat	4
44	88521	4120 S-400	Buffer flach Buffer flat	4
45	88522	4120 S-401	Buffer gewölbt Buffer vaulted	4
46	89440	—	Kuppelstange rechts Connecting rod right	16
47	89441	—	Kuppelstange links Connecting rod left	16
48	88558	—	Buffer flach I. 43273 Buffer flat I. 43273	4
49	88559	—	Buffer gewölbt I. 43273 Buffer vaulted I. 43273	4
50	88560	—	Buffer flach I. 43273 Buffer flat I. 43273	4
51	88561	—	Buffer gewölbt I. 43273 Buffer vaulted I. 43273	4