

Pos. Nr.	Text	Art.-Nr.	Preis-Gruppe
1	Motor komplett <i>Motor assembly</i>	85060	57
2	Halfringesatz <i>Traction tyre set</i>	85622	19
3	Zahnrad z=14l, m 0,4 <i>Gear T=14l, m 0,4</i>	86407	2
4	Schnecke <i>Worm</i>	86701	5
5	Schnecksensatz komplett <i>Worm set assembly</i>	86842	24
6	Kardanschale <i>Cardan bearing</i>	87093	3
7	Universalkupplung <i>Universal coupling</i>	89282	5
8	Radsatz <i>Wheelset</i>	90517	18
9	Inneneinrichtungssatz <i>Interior set</i>	100010	10
10	Radkontaktsatz <i>Wheel set</i>	100012	8
11	Zahnradssatz <i>Gear set</i>	100014	20
12	Getriebesatz komplett <i>Gear part assembly</i>	100581	24
13	Kupplungshalter <i>Coupling holder</i>	100829	2
14	Drehgestell 1 komplett <i>Bogie 1 assembly</i>	101295	53
15	Drehgestell 2 komplett <i>Bogie 2 assembly</i>	101296	53
16	Drehgestellblende 1 komplett <i>Bogie frame 1 assembly</i>	101297	30
17	Drehgestellblende 2 komplett <i>Bogie frame 2 assembly</i>	101298	30
18	Steckteilesatz <i>Push in parts set for bogie</i>	101299	20
19	Lokrahmen <i>Loco frame</i>	108803	30
20	Radsatz mit 2 Halfringen <i>Wheelset with 2 traction tyre</i>	108806	20
21	Zurüstbeutel <i>Bag with accessories</i>	108809	25
22	Werkzeugkasten <i>Loco bottom</i>	108811	5
23	Kühlspirale mit Zylinder <i>Radiator hose with cylinder</i>	108812	3

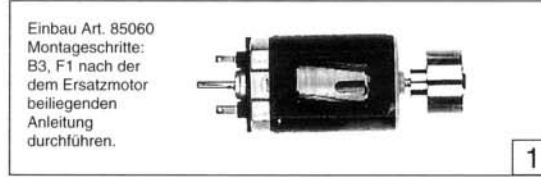

22 o. Abb./ no. ill.  
Werkzeugkasten  
Loco Bottom

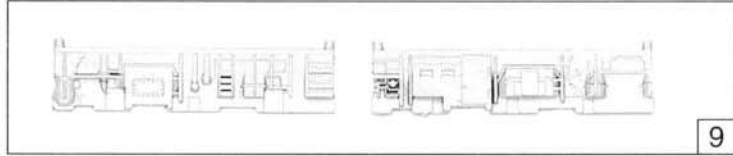
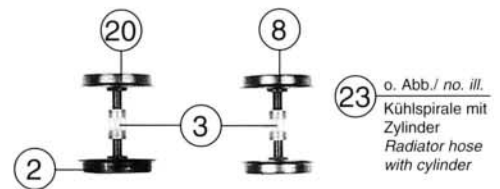
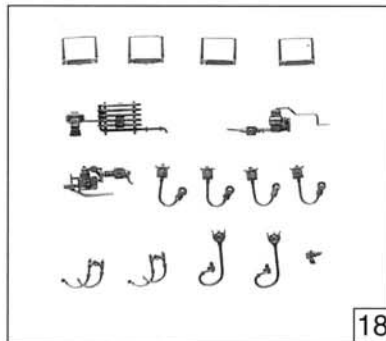
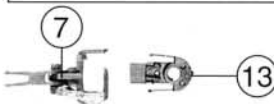
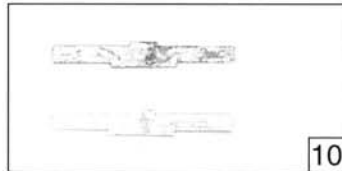
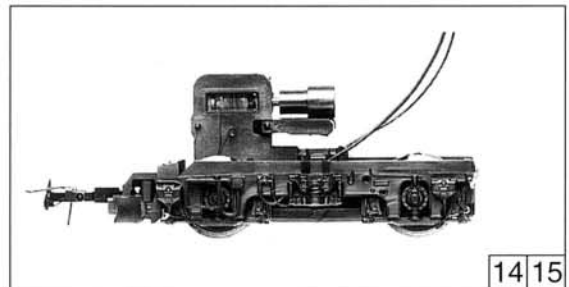
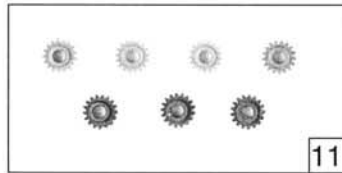
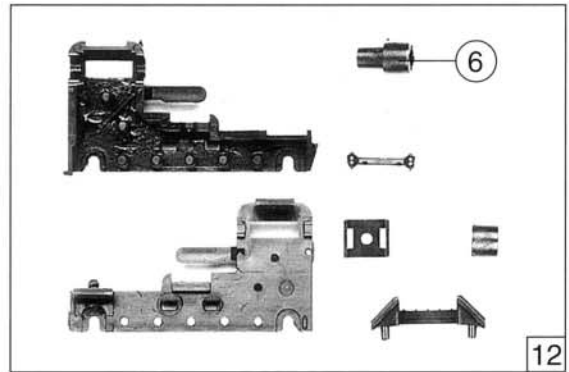
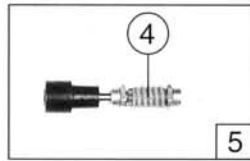
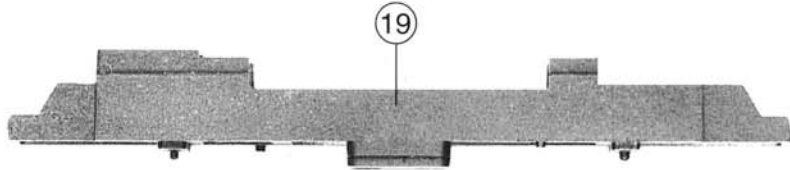

23 o. Abb./ no. ill.  
Kühlspirale mit  
Zylinder  
Radiator hose  
with cylinder

