

13 o. Abb. / no ill.
Sirene
Airhorn
Trompe

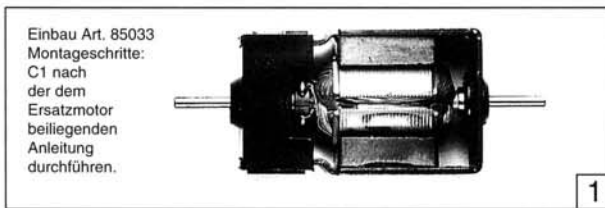

7 o. Abb. / no ill.
Lampenhalter
Holder for head lamp
Couvercle pour feux avant / arrière

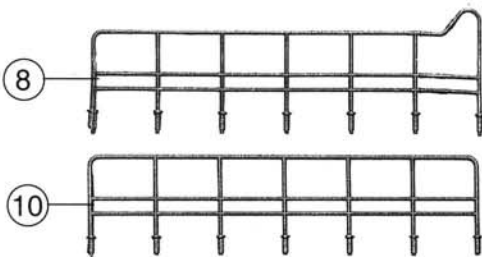
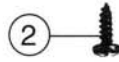
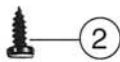
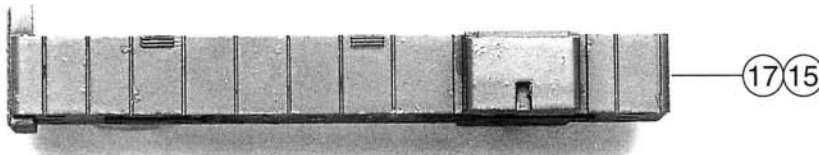
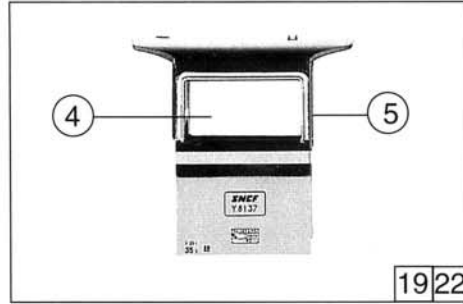
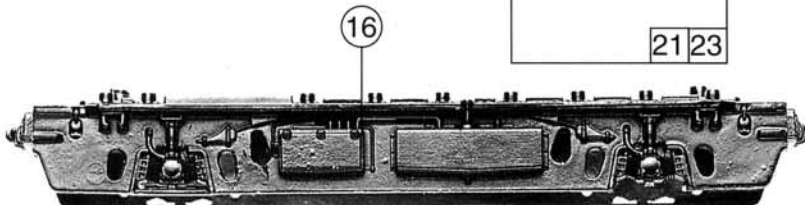
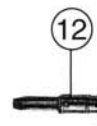
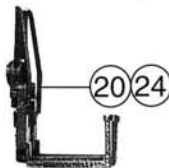

Pos. Nr.	Text	Art.-Nr.	Preisgruppe
1	Motor Motor Moteur	85033	5
2	Schraube 2,2 x 6,5 Screw 2,2 x 6,5 Vis 2,2 x 6,5	85800	2
3	Schnecke Worm Vis sans fin	86701	5
4	Führerhausfenster Cab glazing Fenêtres latérales	95355	5
5	Stirnfenster Front glazing Baies frontales	95356	5
6	Steckteil glasklar Push in part transparent Lentilles claires des feux	95357	2
7	Lampenhalter Holder for head lamp Couvercle pour feux avant / arrière	95359	2
8	Geländer vorne rechts Handrail right front Grand garde-corps à droite	95360	10
9	Geländer hinten rechts Handrail right rear Petit garde-corps à droite	95361	6
10	Geländer vorne links Handrail left front Grand garde-corps à gauche	95362	10
11	Geländer hinten links Handrail left rear Petit garde-corps à gauche	95363	6
12	Puffer Buffer Tampon	95364	3
13	Sirene Airhorn Trompe	95365	2
14	Motorgehäuse für 43475 Motor body for 43475 Partie supérieure des capots f. 43475	95366	25
15	Lokgehäuse für 43475 Loco body for 43475 Partie supérieure capots f. 43475	95367	33
16	Lok-Unterteil Loco frame Chassis	95368	37
17	Lokgehäuse 43577 Loco body 43577 Partie inférieure des capots 43577	100753	33
18	Motorgehäuse 43577 Motor body 43577 Partie supérieure des capots 43577	100754	25
19	Kabine komplett 43577 Betr. Nr. Y 8449 Cab assembly 43577 Betr. No. Y 8449 Cabine entière 43577 n°. Y 8449	105776	41
20	Bühne 43577 Platform 43577 Passerelle 43577	105777	10
21	Bühne komplett 43577 Platform assembly 43577 Ensemble de passerelle 43577	105778	16
22	Kabine komplett 43475 Betr. Nr. Y 8137 Cab assembly 43475 Betr. No. Y 8137 Cabine entière 43475 n°. Y 8137	105779	41
23	Bühne komplett 43475 Platform assembly 43475 Ensemble de passerelle 43475	105780	16
24	Bühne 43475 Platform 43475 Passerelle 43475	105781	10