

43652 43656 43879  
 43655 43656.1 43953  
 43655.5 43656.9 43953.1  
 43655.9 43750 43970.5



# Ersatzteilliste Replacement Parts

Pos./Nr.	Text	Art.-Nr.	Preis/gross
1	Motor	85086	57
2	Motor	85612	17
3	Hafttring Traction tyre	85674	2
4	Schraube 2 x 3 Screw 2 x 3	85676	2
5	Schraube 2 x 12 Screw 2 x 12	86409	2
6	Zahnrad Cogwheel	86413	4
7	Zahnrad Cogwheel	86414	4
8	Zahnrad Cogwheel	86425	2
9	Schnecke Worm	86702	5
10	Schneckensatz Worm set	86877	24
11	Kardankugel Cardan ball	87137	3
12	Standardkupplung Standard coupling	89246	5
13	Radsatz mit Hafttring Wheelset with traction tyre	90677	20
14	Radsatz Wheelset	90678	18
15	Kupplungskammer Coupling chamber	93131	2
16	Schneckendeckel Worm cover	93133	2
17	Getriebesatz Gear part set	100070	26
18	Kardansatz Cardan set	100075	11
19	Zurüstbeutel f. 43655, 43655.5, 43655.9, 43970.5 Bag with accessories f. 43655, 43655.5, 43655.9, 43970.5	100084	25
20	Stoßdämpfer Stock absorber	100088	2
21	Radkontakt Wheel current contact strip	100090	3
22	Gehäuseunterteil Shell	101036	16
23	Blende komplett Bogie frame assembly	101037	28
24	Drehgestell 1 Bogie assembly 1	101223	49
25	Drehgestell 2 Bogie assembly 2	101224	49
26	Zurüstbeutel f. 43656, 43656.1, 43953, 43953.1, 43656.9 Bag with accessories f. 43656, 43656.1 43953, 43953.1, 43656.9	101654	25
*27	Drehgestell 1 f. 43656.1 Bogie 1 f. 43656.1	101657	45
*28	Drehgestell 2 f. 43656.1 Bogie 2 f. 43656.1	101658	45
*29	Blende 2 kpl. f. 43656.1 Bogie frame ass. f. 43656.1	101660	28
*30	Radsatz o. Zahnrad f. 43656.1 Wheelset without gear f. 43656.1	101661	16
*31	Grundrahmen (Plastik) f. 43656.1 Frame (plastic) f. 43656.1	101662	16
32	Zurüstbeutel f. 43652 Bag with accessories f. 43652	101725	25
33	Zurüstbeutel f. 43750, 43897 Bag with accessories f. 43750, 43897	101763	25
34	Grundrahmen Frame	101814	30
35	Schleifer Collector shoe	40003	-
36	Schraube Screw	85670	2
37	Modulhalter Modul holder	89795	6
38	Modul Modul	89940	-
39	Radsatz ohne Zahnrad Wheelset	90698	16
40	Radsatz mit Hafttring mit Zahnrad Wheelset w. traction tyre w. cogwheel	90699	20
41	Getriebe AC Gear	97797	10
42	Drehgestellboden Gear bottom	97798	20
43	Grundrahmen Frame	100275	30
44	Blende komplett Bogie assembly	101038	28
45	Drehgestell mit Schleifer Bogie assembly with collector shoe	101225	53
46	Drehgestell Bogie assembly	101226	55
*47	Grundrahmen (Plastik) f. 43953.1 Frame (plastic) f. 43953.1	101663	16
*48	Drehgestell 1 f. 43953.1 Bogie 1 f. 43953.1	101664	45
*49	Drehgestell 2 f. 43953.1 Bogie 2 f. 43953.1	101931	45

Einbau Art 85086  
Montageschritte F 1  
nach der dem  
Ersatzmotor  
beiliegenden  
Anleitung  
durchführen!

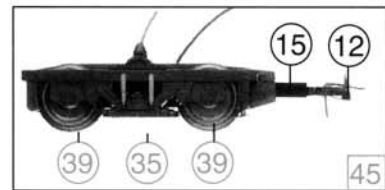
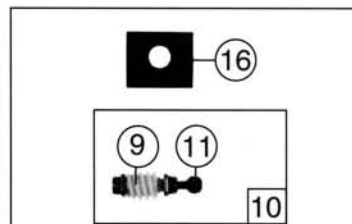
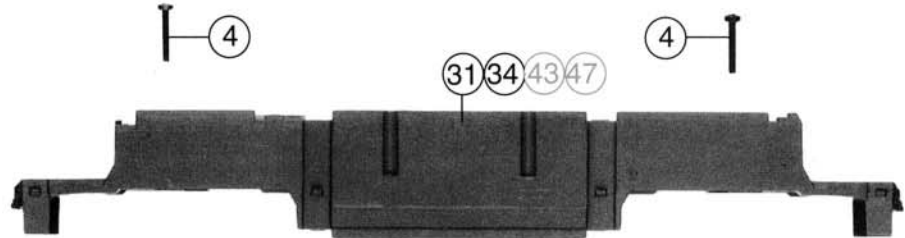
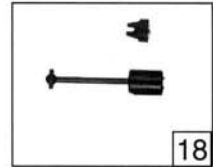

27 o. Abb. / no. ill  
Drehgestell 1  
(Dummy)  
48 Bogie 1 (Dummy)



28 o. Abb. / no. ill  
Drehgestell 2  
(Dummy)  
49 Bogie 2 (Dummy)



30 o. Abb. / no. ill  
Radsatz o. Zahnrad (Dummy)  
Wheelset without gear (Dummy)

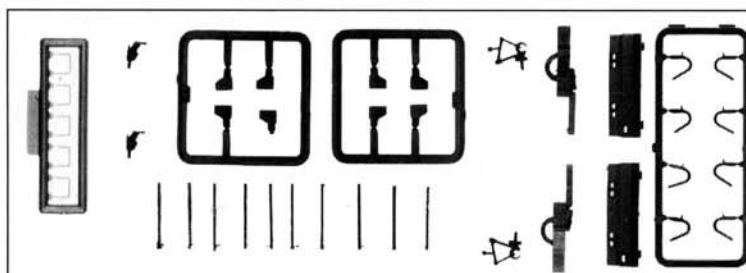
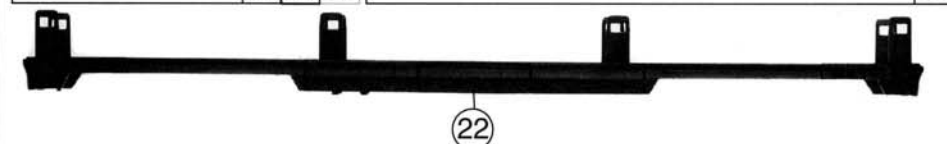
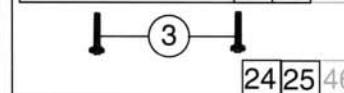
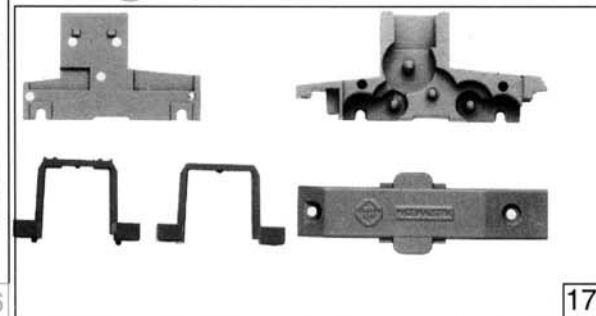
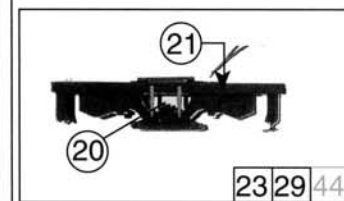
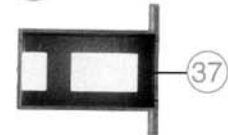
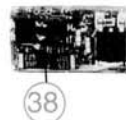
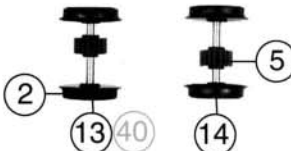
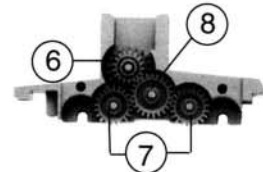

19 26 32 33