

7 11 13

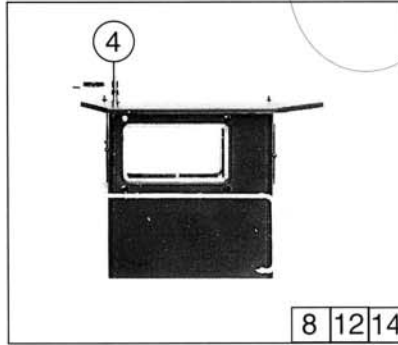

8 12 14

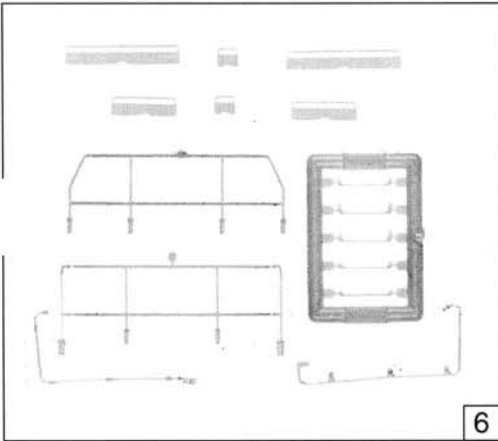

6

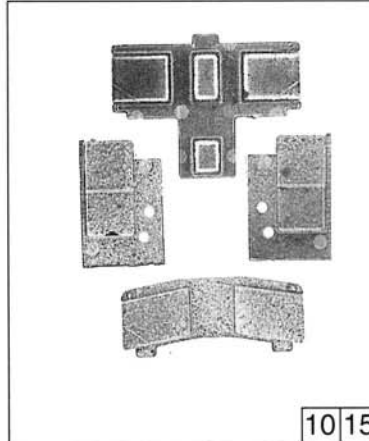

10 15

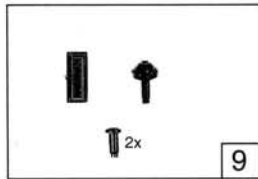

9

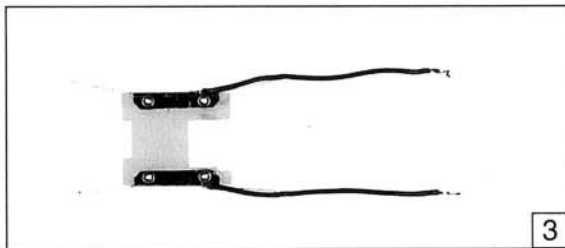

3

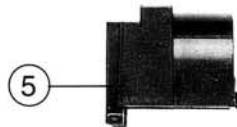

5

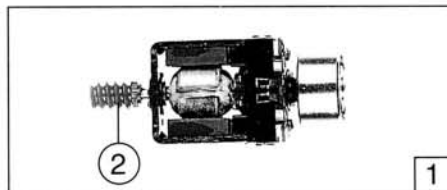

2

1

Roc. Nr.	Text	Art.-Nr.	Preis-gruppe
1	Motor mit Platine <i>Motor with platine</i>	85101	61
2	Schnecke <i>Worm</i>	86705	3
3	Radkontaktplatine komplett <i>Wheel current printed assembly</i>	87813	32
4	Antenne <i>Loco whistle</i>	88002	6
5	Motorabdeckung <i>Motor bearing</i>	105601	3
6	Geländersatz <i>Handrail set</i>	105603	22
7	Vorbaugehäuse komplett für 43728 Betr. Nr. 214.4101 <i>Extension body for 43728</i> Betr. No. 214.4101	105605	34
8	Führerhaus komplett für 43728 Betr. Nr. 214.4101 <i>Cab assembly for 43728</i> Betr. No. 214.4101	105606	44
9	Teilesatz 1 <i>Parts set 1</i>	105609	9
10	Fenstersatz für 43728, 43278.1 <i>Glazing set for 43728, 43278.1</i>	105610	14
★11	Vorbaugehäuse für 43728.1 Betr. Nr. 214.4133 <i>Extension body for 43728.1</i> Betr. No. 214.4133	105614	34
★12	Führerhaus komplett für 43728.1 Betr. Nr. 214.4133 <i>Cab assembly for 43728.1</i> Betr. No. 214.4133	105615	44
★13	Vorbaugehäuse für 43728.2 Betr. Nr. 214.4026 <i>Extension body for 43728.2</i> Betr. No. 214.4026	105617	34
★14	Führerhaus komplett für 43728.2 Betr. Nr. 214.4026 <i>Cab assembly for 43728.2</i> Betr. No. 214.4026	105618	44
★15	Fenstersatz für 43728.2 <i>Glazing set for 43728.2</i>	105619	14