

| Pos. Nr. | Text | Art.-Nr. | Preis-gruppe |
|----------|-----------------------------------------------------|----------|--------------|
| 1 | Motor | 85086 | 57 |
| 2 | Motor | | |
| 2 | Haltring | 85612 | 17 |
| 3 | Traction tyre | | |
| 3 | Schraube 2 x 8 | 85674 | 2 |
| 3 | Screw 2 x 8 | | |
| 4 | Schraube 2 x 12 | 85676 | 2 |
| 4 | Screw 2 x 12 | | |
| 5 | Zahnrad | 86409 | 2 |
| 5 | Cogwheel | | |
| 6 | Zahnrad | 86413 | 4 |
| 6 | Cogwheel | | |
| 7 | Zahnrad | 86414 | 4 |
| 7 | Cogwheel | | |
| 8 | Zahnrad | 86425 | 2 |
| 8 | Cogwheel | | |
| 9 | Schnecke | 86702 | 5 |
| 9 | Worm | | |
| 10 | Schneckensatz | 86877 | 24 |
| 10 | Worm set | | |
| 11 | Kardankugel | 87137 | 3 |
| 11 | Cardan ball | | |
| 12 | Standardkupplung | 89246 | 5 |
| 12 | Standard coupling | | |
| 13 | Radsatz mit Haltring | 90677 | 20 |
| 13 | Wheelset with traction tyre | | |
| 14 | Radsatz | 90678 | 18 |
| 14 | Wheelset | | |
| 15 | Kupplungskammer | 93131 | 2 |
| 15 | Coupling chamber | | |
| 16 | Schneckendeckel | 93133 | 2 |
| 16 | Worm cover | | |
| 17 | Getriebesatz | 100070 | 26 |
| 17 | Gear part set | | |
| 18 | Kardansatz | 100075 | 11 |
| 18 | Cardan set | | |
| 19 | Zurüstbeutel für 43751, 43752, 43881, 43878 | 100084 | 25 |
| 19 | Bag with accessories for 43751, 43752, 43881, 43878 | | |
| 20 | Grundrahmen | 100085 | 30 |
| 20 | Frame | | |
| 21 | Stoßdämpfer | 100088 | 2 |
| 21 | Stock absorber | | |
| 22 | Radkontakt | 100090 | 3 |
| 22 | Wheel current contact strip | | |
| 23 | Gehäuseunterteil | 101036 | 16 |
| 23 | Shell | | |
| 24 | Blende komplett | 101037 | 28 |
| 24 | Bogie frame assembly | | |
| 25 | Drehgestell 1 | 101223 | 49 |
| 25 | Bogie assembly 1 | | |
| 26 | Drehgestell 2 | 101224 | 49 |
| 26 | Bogie assembly 2 | | |
| 27 | Zurüstbeutel für 43652 | 101725 | 25 |
| 27 | Bag with accessories for 43652 | | |
| 28 | Zurüstbeutel für 43750, 43879 | 101763 | 25 |
| 28 | Bag with accessories for 43750, 43879 | | |
| 29 | Schleifer | 40003 | - |
| 29 | Collector shoe | | |
| 30 | Schraube | 85670 | 2 |
| 30 | Screw | | |
| 31 | Modulhalter | 89795 | 6 |
| 31 | Modul holder | | |
| 32 | Modul | 89940 | - |
| 32 | Modul | | |
| 33 | Radsatz ohne Zahnrad | 90698 | 16 |
| 33 | Wheelset | | |
| 34 | Radsatz mit Haltring mit Zahnrad | 90699 | 20 |
| 34 | Wheelset w. traction tyre w. cogwheel | | |
| 35 | Getriebe AC | 97797 | 10 |
| 35 | Gear | | |
| 36 | Drehgestellboden | 97798 | 20 |
| 36 | Gear bottom | | |
| 37 | Grundrahmen | 100275 | 30 |
| 37 | Frame | | |
| 38 | Blende komplett | 101038 | 28 |
| 38 | Bogie assembly | | |
| 39 | Drehgestell mit Schleifer | 101225 | 53 |
| 39 | Bogie assembly with collector shoe | | |
| 40 | Drehgestell | 101226 | 55 |
| 40 | Bogie assembly | | |

Einbau Art 85086
 Montageschritte F1
 nach der dem
 Ersatzmotor
 beiliegenden
 Anleitung
 durchführen!

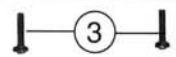

25 26 40

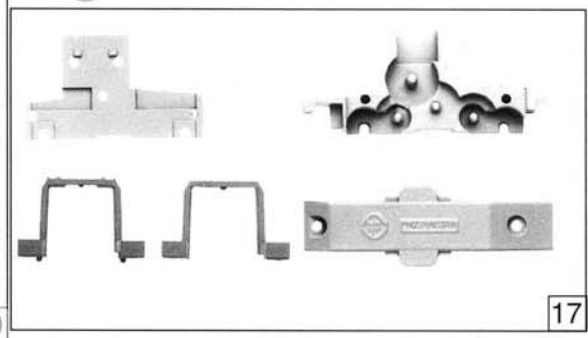
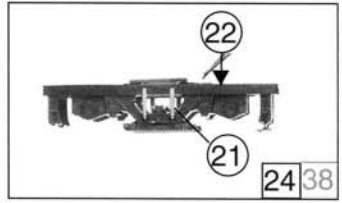
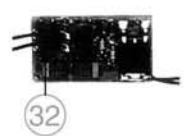
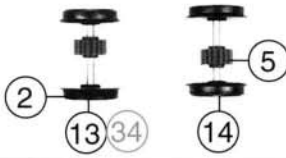
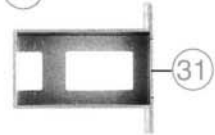
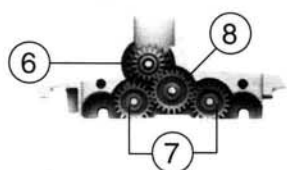
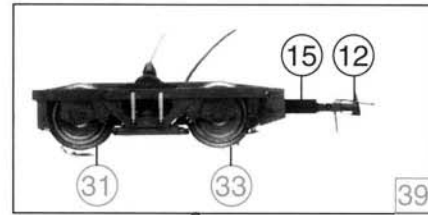
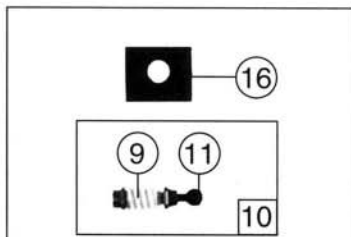
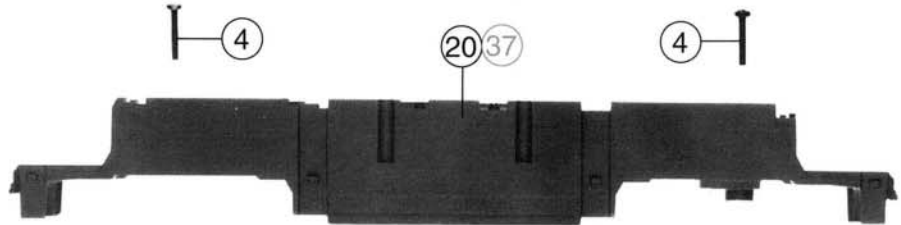
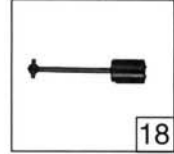
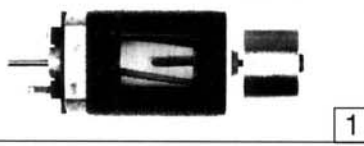
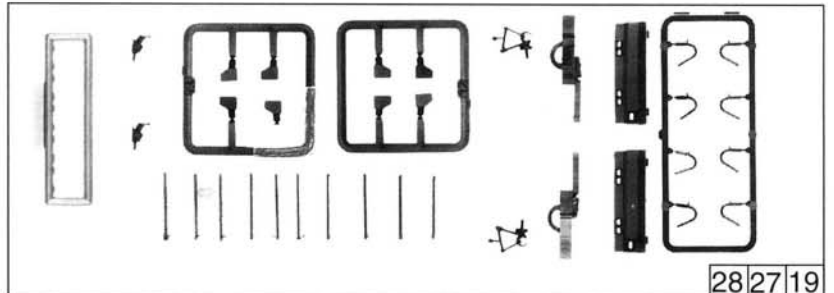

28 27 19