

14 20 o. Abb. / no ill.
Dachlüfter-Antennensatz
Roof lifter-Antenna set

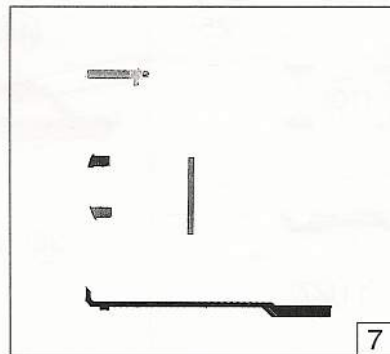

Pos. Nr.	Text	Art.-Nr.	Preis
1	Schraube M 2 x 25 Screw/Screw M 2 x 25	85759	3
2	Lokpfeife Loco whistle	88002	6
3	Kontaktstreifen Contact strip	89778	4
4	Löffane Contact	89962	2
5	Sofitle 16 V Tubular lamp 16 V	93517	10
6	Lichtleitstäbesatz 1 Light transmissions bar set 1	101780	16
7	Lichtleitstäbesatz 2 Light transmissions bar set 2	101781	16
8	Stirnfensersatz Glazing set	101840	10
9	Gehäuse für 63004 St.w. 1 Betr.-Nr. 420 191-9 Body for 63004 St. w. 1 Betr.-No. 420 191-9	111562	49
10	Dach für 63004, 69004 Roof wire for 63004, 69004	111564	25
11	Gehäuse für 63004 St.w. 2 Betr.-Nr. 420 691-8 Body for 63004 St. w. 2 Betr.-No. 420 691-8	111566	49
12	Fenstersatz für 63004, 69004 Glazing set for 63004, 69004	111568	25
13	Führerstandeinrichtung f. 63004, 69004 Drivers cab interior f. 63004, 69004	111569	3
14	Dachlüfter-Antennensatz für Motor- und Steuerwagen f. 63004, 69004, o. Abb. Roof lifter-Antenna set f. powers- and drawing trailer f. 63004, 69004, no ill.	111571	18
15	Dach für 63006, 69006 Roof for 63006, 69006	111583	25
16	Gehäuse für 63006 St.w. 1 Betr.-Nr. 420 199-2 Body for 63006 St. w. 1 Betr.-No. 420 199-2	111587	49
17	Gehäuse für 63006 St.w. 2 Betr.-Nr. 420 699-1 Body for 63006 St. w. 2 Betr.-No. 420 699-1	111591	49
18	Fenstersatz für 63006, 69006 Glazing set for 63006, 69006	111592	25
19	Führerstandeinrichtung f. 63006, 69006 Drivers cab interior f. 63006, 69006	111593	3
20	Dachlüfter-Antennensatz für Motor- und Steuerwagen f. 63006, 69006, o. Abb. Roof lifter-Antenna set f. powers- and drawing trailer f. 63006, 69006, no ill.	111594	18
21	Gehäuse für 69004 St.w. 1 Betr.-Nr. 420 191-9 Body for 69004 St. w. 1 Betr.-No. 420 191-9	111573	49
22	Gehäuse für 69004 St.w. 2 Betr.-Nr. 420 691-8 Body for 69004 St. w. 2 Betr.-No. 420 691-8	111574	49
23	Gehäuse 1 für 69006 St.w. 1 Betr.-Nr. 420 199-2 Body for 69006 St. w. 1 Betr.-No. 420 199-2	111598	49
24	Gehäuse für 69006 St.w. 2 Betr.-Nr. 420 699-1 Body for 69006 St. w. 2 Betr.-No. 420 699-1	111599	49

Pos.-Nr.	Text	Art.-Nr.	Preis-gruppe
1	Schraube M 2 x 5 <i>Screw M 2 x 5</i>	85715	2
2	Schraube M 2,2 x 9,5 <i>Screw M 2,2 x 9,5</i>	85808	2
3	Platine kpl. f. Steuerwagen <i>Printed circuit ass. f. drawing trailer</i>	87692	22
4	E-Lokführer <i>Loco driver</i>	89732	5
5	Gewicht <i>Weight</i>	93416	14
6	Glühlampe 16 V <i>Lamp 16 V</i>	93518	12
7	Glühlampe rot 16 V <i>Lamp red 16 V</i>	93522	14
8	Radkontakt <i>Contact strip</i>	100062	8
9	Kupplung für 63006, 69006 <i>Coupling for 63006, 69006</i>	101785	3
10	Radsatz <i>Wheelset</i>	101786	16
11	Abdeckplatte vorne für 63006, 69006 <i>Cover plate front for 63006, 69006</i>	101787	6
12	Abdeckplatte hinten für 63006, 69006 <i>Cover plate rear for 63006, 69006</i>	101788	6
13	Abdeckplatte für 63006, 69006 <i>Cover plate for 63006, 69006</i>	101789	2
14	Drehgestellblende 1 für 63006, 69006 <i>Bogie frame 1 for 63006, 69006</i>	101790	12
15	Drehgestellblende 2 für 63006, 69006 <i>Bogie frame 2 for 63006, 69006</i>	101791	12
16	Drehgestell 1 komplett für 63006 <i>Bogie 1 assembly for 63006</i>	101792	40
17	Drehgestell 2 komplett für 63006 <i>Bogie 2 assembly for 63006</i>	101793	40
18	Drehschemel mit Zapfen <i>Balance holder with pin</i>	101846	4
19	Drehschemel ohne Zapfen <i>Balance holder without pin</i>	101847	4
20	Aufreiber o. Abb. <i>Decals no ill.</i>	107271	14
21	Drehgestell 1 Steuerw. für 63004 <i>Bogie assembly 1 flywheel for 63004</i>	107279	40
22	Drehgestell 2 Steuerw. für 63004 <i>Bogie assembly 2 flywheel for 63004</i>	107280	40
23	Kupplungsführung für 63004, 69004 <i>Coupling for 63004, 69004</i>	107283	3
24	Scharfenbergkupplung f. 63004, 69004 <i>Scharfenberg coupling f. 63004, 69004</i>	107285	3
25	Drehgestellblende 1 Stw. für 63004, 69004 <i>Bogie frame 1 f. 63004, 69004</i>	107292	23
26	Drehgestellblende 2 Stw. für 63004, 69004 <i>Bogie frame 2 für 63004, 69004</i>	107293	23
27	Abdeckplatte vorne für 63004, 69004 <i>Cover plate front for 63004, 69004</i>	107294	8
28	Abdeckplatte hinten für 63004, 69004 <i>Cover plate rear for 63004, 69004</i>	107295	6
29	Scharfenbergkupplung f. 63006, 69006 <i>Scharfenberg coupler f. 63006, 69006</i>	107313	3
30	Bodenplatte 1 für 63004, 69004 <i>Main frame 1 for 63004, 69004</i>	111563	30
31	Abdeckplatte f. Diode f. 63004, 69004 <i>Cover plate f. Diode f. 63004, 69004</i>	111565	2
32	Bodenplatte 2 für 69004, 63004 <i>Main frame 2 for 69004, 63004</i>	111567	30
33	Inneneinrichtungssatz Stw. für 63004, 69004 <i>Interior set for 63004, 69004</i>	111570	30
34	Bodenplatte Stw. 1 für 69006, 63006 <i>Main frame 1 for 69006, 63006</i>	111588	30
35	Bodenplatte Stw. 2 für 63006, 69006 <i>Main frame 2 for 63006, 69006</i>	111596	30
36	Schraube für 69004, 69006 <i>Screw for 69004, 69006</i>	85727	2
37	Platine komplett für 69004, 69006 <i>Printed circuit ass. f. 69004, 69006</i>	87851	22
38	Drehgestell 1 Stw. 1 für 69004 <i>Bogie assembly 1 for 69004</i>	107299	43
39	Drehgestell 2 Stw. 1, 2 für 69004 <i>Bogie assembly 2 for 69004</i>	107300	40
40	Drehgestell 1 Stw. 2 mit Indusi f. 69004 <i>Bogie assembly 1 for 69004</i>	107302	37
41	Drehgestell 1 Stw. 1 für 69006 <i>Bogie assembly 1 for 69006</i>	107323	43
42	Drehgestell 2 Stw. 1, 2 für 69006 <i>Bogie assembly 2 for 69006</i>	107324	40
43	Drehgestell 1 Stw. 2 mit Indusi f. 69006 <i>Bogie assembly 1 for 69006</i>	107327	37
44	Schleifer <i>Collector</i>	40064	-

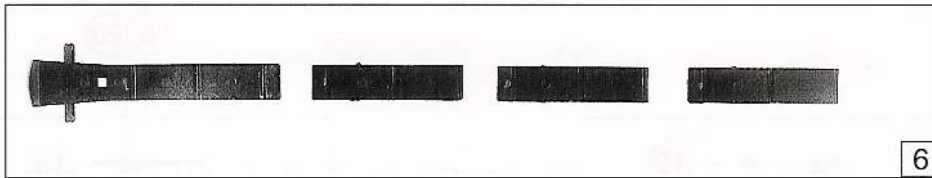
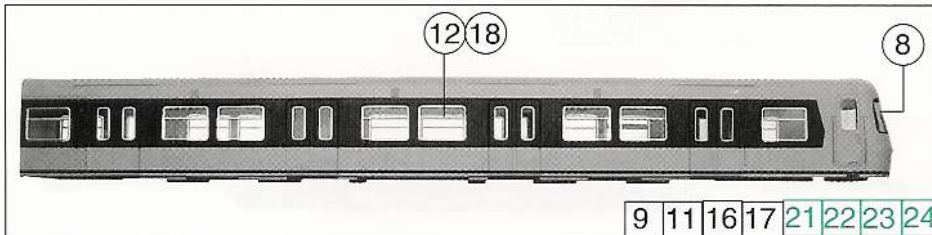
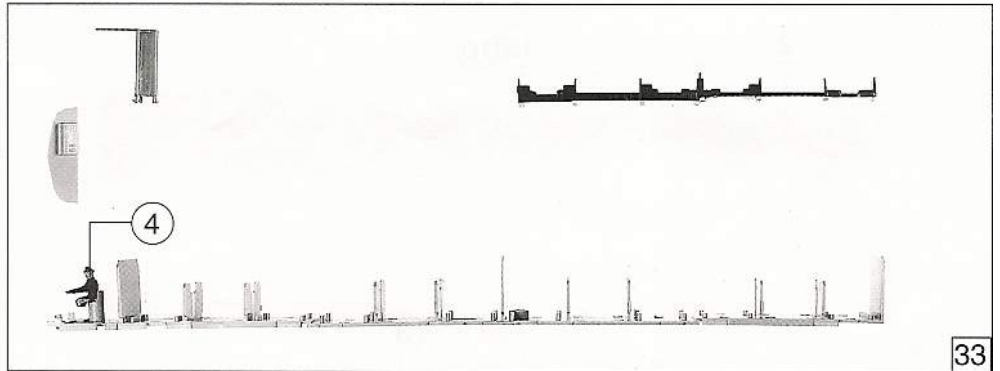

33

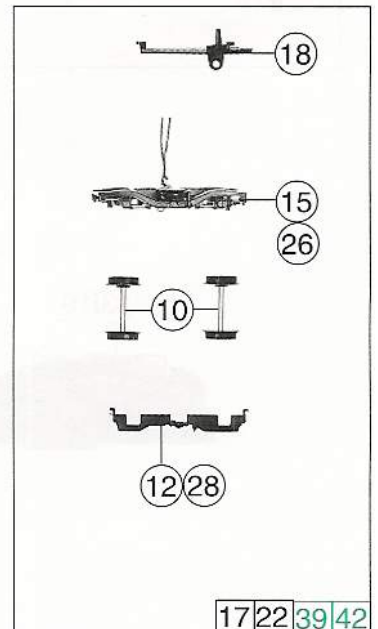
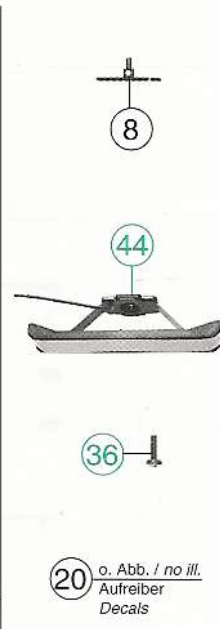
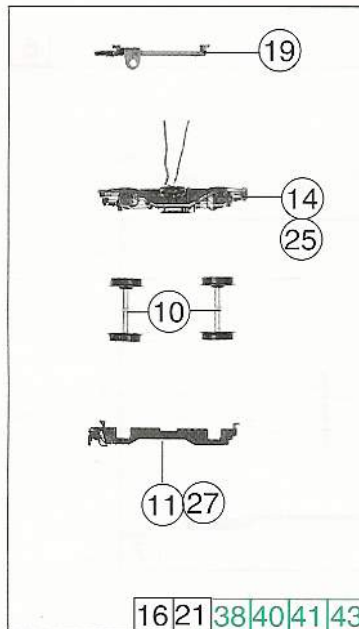
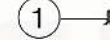
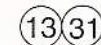
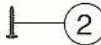
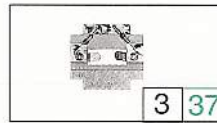
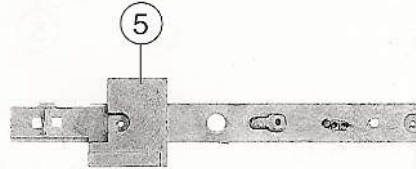
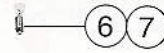

20 o. Abb. / no ill.
Aufreiber
Decals

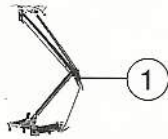

21 o. Abb. / no ill.
Isolatorsatz
Insulator set

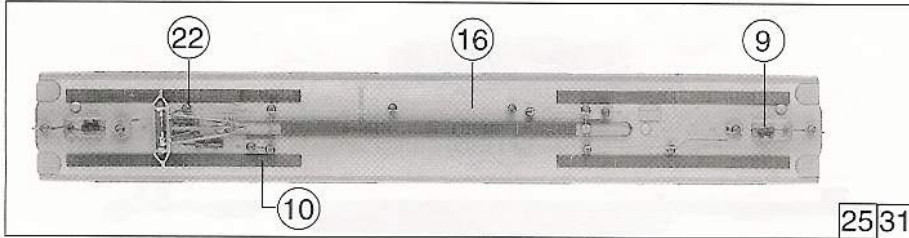

28 o. Abb. / no ill.
Bremsrad rot
Hand wheel red

27 33 o. Abb. / no ill.
Laufstegsatz
Gangway set



29 o. Abb. / no ill.
Bremsrad blau
Hand wheel blue

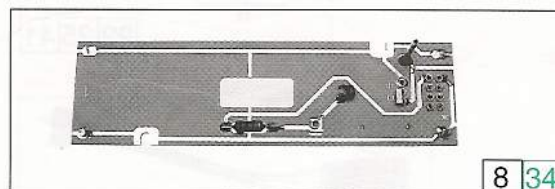
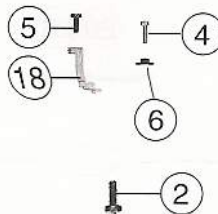
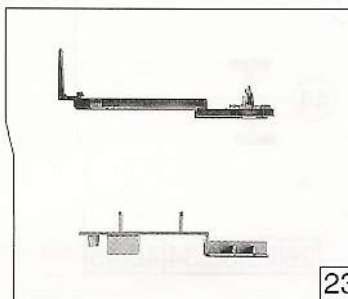
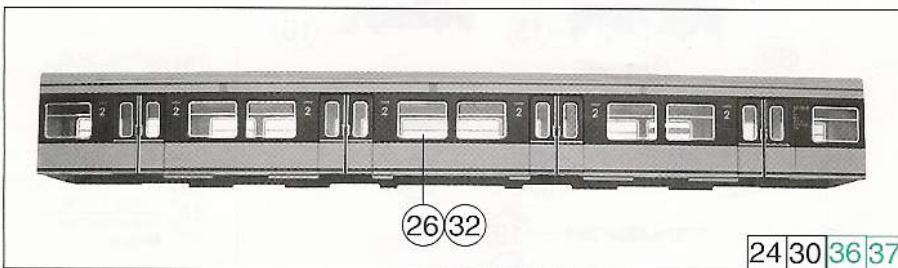
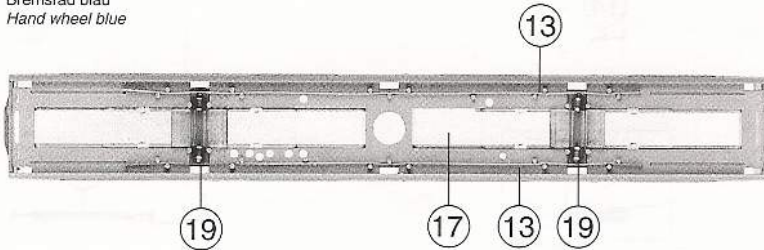

Pos. Nr.	Text	Art.-Nr.	Preis-Gruppe
1	Stromabnehmer Pantograph	85297	38
2	Schraube M 2 x 6 Screw M 2 x 6	85672	2
3	Schraube M 1,6 x 5 Screw M 1,6 x 5	85692	2
4	Schraube M 1,6 x 8 Screw M 1,6 x 8	85695	2
5	Schraube M 2 x 5 Screw M 2 x 5	85715	2
6	Isolierhülse Insulating tube	86111	2
7	Feder Spring	86215	2
8	Platine komplett Printed assembly	87856	43
9	Hauptschalter Main switch	88175	3
10	Isolator Insulator	88176	3
11	Umschaltkontakt Switch contact	89709	3
12	Schaltbolzen Switch pin	89721	9
13	Kontaktstreifen Contact strip	89776	4
14	Oberleitungsverbinder Overhead supply connector	89778	4
16	Dachleitungssatz Roof wire set	93430	12
17	Leuchstab Light transmissions bar	93434	4
18	Platinenhalter Printed circuit holder	93436	2
19	Sofitte Tubular-lamp	93517	10
20	Brückenstecker Connector	100644	7
21	Isolatorenset o. Abb. Insulator set no ill.	101764	34
22	Stromabnehmerisolator Pantograph insulator	101769	2
23	Inneneinrichtungssatz Interior set	107277	12
24	Gehäuse Motorw. für 63004 Betr.-Nr. 421 191-8 Body power car for 63004 Betr.-No. 421 191-8	111558	49
25	Dach komplett Motorw. für 63004, 69004 Roof assembly for 63004, 69004	111559	52
26	Fenstersatz Motorwagen, Steuerwagen für 63004, 69004 Glazing set	111568	25
27	Laufstegsatz f. 63004, 69004 Gangway set f. 63004, 69004	111579	9
28	Bremsrad für 63004, 69004 Hand wheel for 63004, 69004	111580	2
29	Bremsrad für 63006, 69006 Hand wheel for 63006, 69006	111581	2
30	Gehäuse Motorw. für 63006 Betr.-Nr. 421 199-1 Body power car for 63006 Betr.-No. 421 199-1	111582	49
31	Dach komplett Motorw. f. 63006, 69006 Roof assembly for 63006, 69006	111583	52
32	Fenstersatz für 63006, 69006 Glazing set for 63006, 69006	111592	25
33	Laufstegsatz f. 63006, 69006 Gangway set f. 63006, 69006	111595	9
34	Platine komplett für 69004, 69006 Printed circuit assembly for 69004, 69006	87850	43
35	Brückenstecker Connector	100645	7
36	Gehäuse komplett Motorw. f. 69004 Betr.-Nr. 421 191-8 Body assembly for 69004 Betr.-No. 421 191-8	111572	49
37	Gehäuse komplett Motorw. für 69006 Betr.-Nr. 421 199-1 Body assembly for 69006 Betr.-No. 421 199-1	111597	49

Pos. Nr.	Text	Art.-Nr.	Preisgruppe
1	Motor mit Schwungscheibe <i>Motor with flywheel</i>	85123	57
2	Hafringsatz <i>Traction tyre set</i>	85622	19
3	Schraube M 2 x 5 <i>Screw M 2 x 5</i>	85715	2
4	Zahnrad z=12; m 0,4 <i>Gear T=12; m 0,4</i>	86430	2
5	Zahnrad z=19; m 0,4 <i>Gear T=19; m 0,4</i>	86431	2
6	Zahnrad z=24; m 0,4 <i>Gear T=24; m 0,4</i>	86432	2
7	Zahnrad z=19; m 0,4 <i>Gear T=19; m 0,4</i>	86433	2
9	Kardanwelle <i>Cardan shaft</i>	87056	3
10	Kardanschale kurz <i>Cardan bearing short</i>	87057	3
11	Kardanschale lang <i>Cardan bearing short</i>	87076	2
12	Radkontakt <i>Wheel contact</i>	89858	3
13	Motorhalter <i>Motor holder</i>	93438	28
14	Getriebeklammer <i>Gear clamp</i>	93442	2
15	Getriebekasten links <i>Gear left</i>	93443	10
16	Getriebedeckel rechts <i>Gear cover right</i>	93444	10
17	Schneckensatz <i>Worm set</i>	101770	24
18	Kupplungsführung für 63006 69006 <i>Coupling for 63006, 69006</i>	101771	3
19	Drehgestellblende für 63006, 69006 <i>Bogie frame for 63006, 69006</i>	101772	12
20	Getriebeabdeckung für 63006, 69006 <i>Gear cover for 63006, 69006</i>	101773	5
21	Radsatz für 63004, 63006 <i>Wheelset for 63004, 63006</i>	101777	18
22	Zurüstbeutel für 63006, 69006 <i>Bag with accessories f. 63006, 69006</i>	101817	8
23	Wippe 1 <i>Balance holder 1</i>	101845	3
24	Wippe 2 <i>Balance holder 2</i>	105006	3
25	Zurüstbeutel für 63004, 69004 <i>Bag with accessories for 63004, 69004</i>	107268	8
26	Drehgestell kpl. für 63004 <i>Bogie assembly for 63004</i>	107274	51
27	Blende Motorw. für 63004, 69004 <i>Bogie for 63004, 69004</i>	107290	12
28	Getriebeabdeckung für 63004, 69004 <i>Gear cover for 63004, 69004</i>	107291	5
29	Drehgestell mit Hafringen für 63004 <i>Bogie assembly with traction f. 63004</i>	107368	52
30	Radsatz mit 2 Hafr. f. 63004, 63006 <i>Wheelset with 2 traction f. 63004, 63006</i>	107370	20
31	Bodenplatte Motorw. f. 63004, 69004 <i>Main frame for 63004, 69004</i>	111560	30
32	Kupplungsführung für 63004, 69004 <i>Coupling for 63004, 69004</i>	111561	3
33	Drehgestell ohne Hafring für 63006 <i>Bogie assembly without traction f. 63006</i>	111584	51
34	Drehgestell mit Hafring für 63006 <i>Bogie assembly with traction f. 63006</i>	111585	52
35	Bodenplatte Motorw. für 63006, 69006 <i>Main frame for 63006, 69006</i>	111586	30
36	Locdecoder Motorola <i>Locdecoder motorola</i>	10738	-
38	Sechskantmutter für 69004, 69006 <i>Nut for 69004, 69006</i>	86004	2
39	Hafringesatz <i>Traction tyre set</i>	85623	16
40	Drehgestell kpl. Motorw. für 69004 <i>Bogie assembly for 69004</i>	107297	51
41	Zurüstbeutel für 69004, 69006 <i>Bag with accessories f. 69004, 69006</i>	107303	15
42	Radsatz mit 2 Haltringen für 69004, 69006 <i>Wheelset with 2 traction for 69004, 69006</i>	107304	20
43	Radsatz ohne Haltring für 69004, 69006 <i>Wheelset without traction for 69004, 69006</i>	107305	18
44	Radsatz ohne Zahnrad f. 69004, 69006 <i>Wheelset without gear f. 69004, 69006</i>	107306	16
45	Drehgestell kpl. Motorw. für 69006 <i>Bogie ass. for 69006</i>	107320	51
46	Einbaubuchse für 69004, 69006 <i>Male shaft for 69004, 69006</i>	107534	2

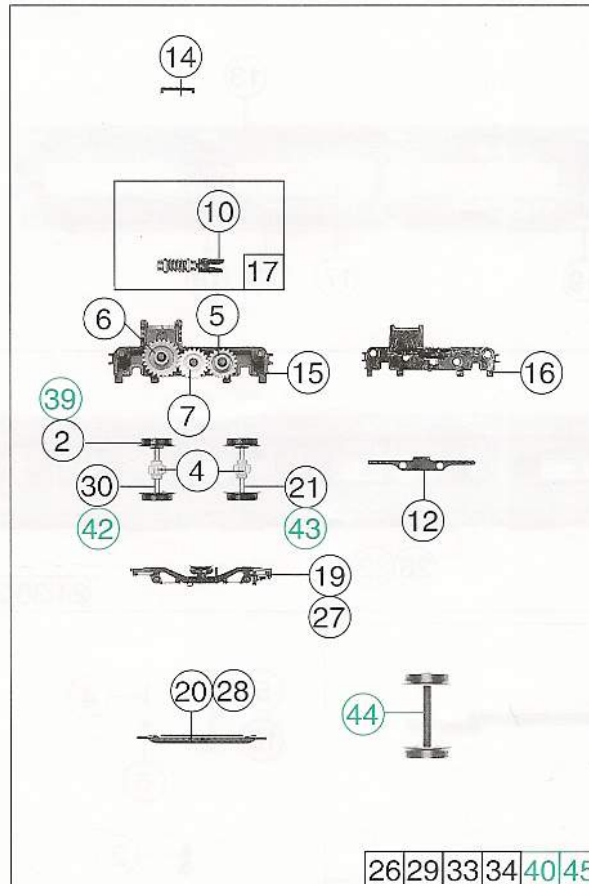
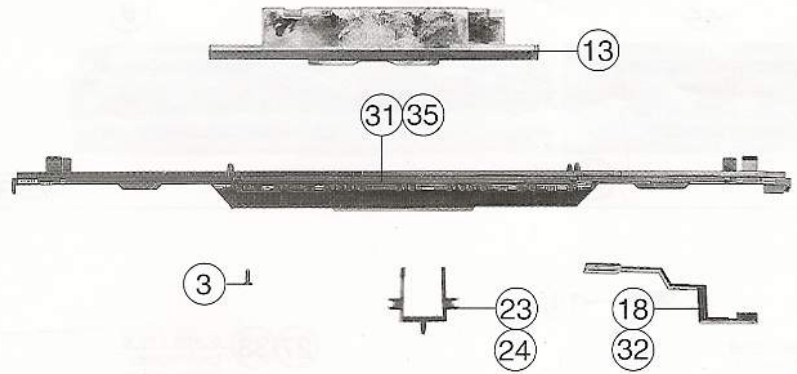
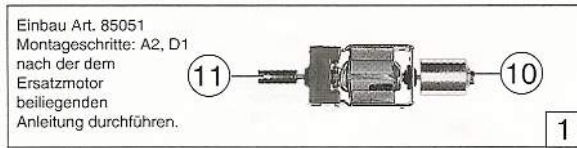

38 o. Abb. / no ill.
Sechskantmutter
Nut

46 o. Abb. / no ill.
Einbaubuchse
Male shaft

