

Pos.Nr. Pos.no. Position	Beschreibung Description Désignation	Preisgruppe Price bracket Catégorie de prix	Art.-Nr. Art.no. Réf.
1	Motor	85093	57
2	Stromabnehmer	85394	39
3	Schraube M 2X6	85672	2
4	Schraube M 2X5	85693	2
5	Schraube 2,2X9,5	85808	2
6	Scheibe	86108	2
7	Feder	86202	2
8	Schneckenrad gelb	86413	4
9	Zahnrad Z=21	86414	2
10	Zahnrad Z=29	86467	2
11	Zahnrad Z=29	86468	2
12	Schnecke gelb M 0.5	86702	5
13	Schneckensatz	86977	24
14	Kardanschale kurz	87129	3
15	Kardanwelle	87154	2
16	Lokpfeife	88002	6
17	Antenne	88030	4
18	Puffer flach	88502	4
19	Puffer gewölbt	88503	4
20	Universalkupplung	89282	5
21	Gummibettung	89728	3
22	Lager für Schneckenachse	89749	6
23	Radsatz o. Haftring	90833	18
24	Kardanschale	95812	2
25	Ansatzschraube M2X8	100101	3
26	Radkontakt	100256	2
27	Lichtleiterabdeckung	100597	3
28	Isolatorsatz	100602	27
29	Dachleitung lack.	100614	10
30	Dachleitung	100615	6
31	Dachleitung	100616	6
32	Brückenstecker	100644	7
33	Distanzplättchen	106116	2
34	Lichtleiter rot	106308	3
35	Radsatz m. 2 Haftringen	107378	20
36	Fenster-Lichtleitstäbesatz	107379	20
37	Oberleitungskontakt	107673	3
38	Attrappenrahmen klein	107808	3
39	Schneckendeckel m. Stab. Feder	108129	8
40	Drahtlampe T3/4 16V 30mA	108616	10
41	Steckteilesatz	108810	20
42	Lampe ST2.8 T3/4 16V 30 mA	109088	12
43	Getriebebesatz	109090	24
44	Zahnrad Z=16	109251	2
45	Fensterblendensatz	111331	7
46	Führerstand	111337	6
47	Griffesatz	111341	8
48	Senkantrieb	112659	3
49	Platine kpl.	112933	43
50	Kontakthalter	113165	3
51	Grundrahmen	113324	30
52	Batteriekasten	114623	3
53	Kühlschlange	114624	3
54	Lampen-Flexplatine	114625	27
55	Federblech	114626	2
56	Gehäuse kpl.	114627	68
57	Zurüstbeutel	114628	28
58	Modulkasten Lichtabdeckungssatz	114629	7
59	Lack. Dachaufbau	114630	7
60	Maschinenfenster	114631	3
61	Pufferbrüst	114632	2
62	UIC-Steckdose	114633	2
63	Auftritt Stirn	114634	2
64	Lüfter ES eckig	114635	3
65	Blende 1 kpl.	114636	25
66	Blende 2 kpl.	114637	25
67	Sifa	114638	2
68	Federblok	114639	2
Abweichende Teile 63701			
69	Senkantrieb	106553	3
70	Gehäuse kpl.	114640	68
71	Zurüstbeutel	114641	28
72	Lack. Dachaufbau	114642	7
73	Maschinenfenster	114643	3
74	UIC-Steckdose	114644	2
75	Auftritt Stirn	114645	2
76	Lüfter ES eckig	114646	3
~ AC Wechselstrom			
77	Decoder Motorola m.Lastr. last	10738	---
78	AC-Flüsterschleifer kurz	40064	---
79	Haftrings.10Stk.12,5-15,3mm	40075	---
80	Radsatz mit 2 Haftringen	90834	20
81	Radsatz o. Zahnrad	90835	16
82	Radsatz o. Haftring	90836	18
83	GETRIEBE	100623	6
84	Getriebeboden für Schleifer	109114	6
85	Schraube M 1,6X5	110008	2

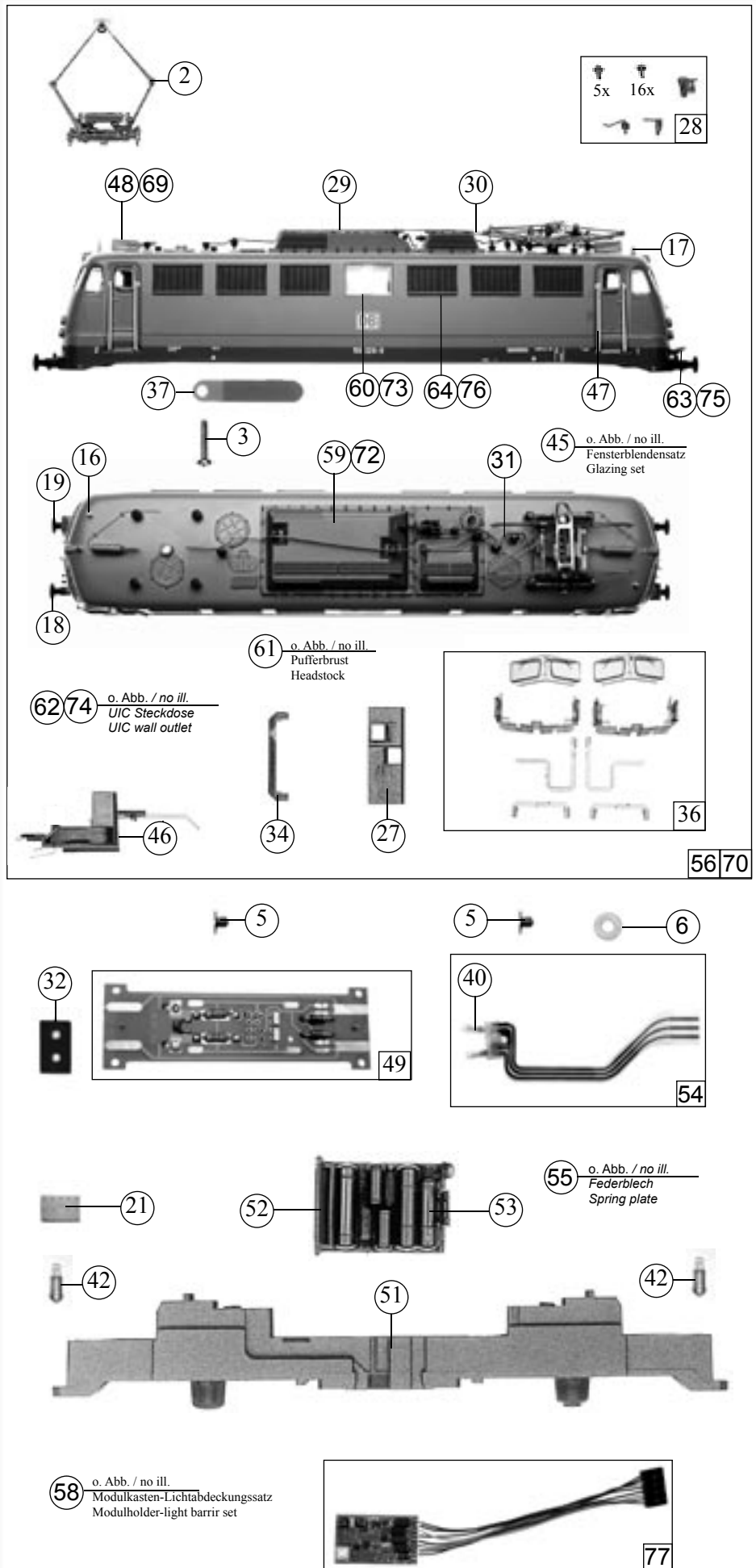

Pos.Nr. Pos.no. Position	Beschreibung Description Désignation	Preisgruppe Price bracket Catégorie de prix	Art.-Nr. Art.no. Réf.
1	Motor		85093 57
2	Pantograph		85394 39
3	Screw M2x6		85672 2
4	Screw M 2x5		85693 2
5	Screw 2.2x9.5		85808 2
6	Disk		86108 2
7	Spring		86202 2
8	Worm gear yellow		86413 4
9	Gear z=21		86414 2
10	Gear z=29		86467 2
11	Gear z=29		86468 2
12	Worm yellow M 0,5		86702 5
13	Worm set		86977 24
14	Cardan shell short		87129 3
15	Cardan Shaft		87154 2
16	Loco whistle		88002 6
17	Antenna		88030 4
18	Buffer flat		88502 4
19	Buffer vaulted		88503 4
20	Universal coupling		89282 5
21	Rubber embedding		89728 3
22	Bearing for Worm axle		89749 6
23	Wheelset without traction tyre		90833 18
24	Cardan jacket		95812 2
25	Screw M2x8		100101 3
26	Wheel contact		100256 2
27	Light cover		100597 3
28	Insulator set		100602 27
29	Roof wire, painted		100614 10
30	Roof wire		100615 6
31	Roof wire		100616 6
32	Connector		100644 7
33	Spacer		106116 2
34	Light transmission red		106308 3
35	Wheelset with 2 traction tires		107378 20
36	Glazing set		107379 20
37	Overhead supply connector		107673 3
38	Push in part set, small		107808 3
39	Worm cover		108129 8
40	Bulb T3/4 16V 30mA		108616 10
41	Parts set		108810 20
42	Light bulb 16V 30 mA		109088 12
43	Gear set		109090 24
44	Gear z=16		109251 2
45	Glazing set		111331 7
46	Drivers cab		111337 6
47	Hand rail set		111341 8
48	Hoist mechanism		112659 3
49	Printed circuit assembly		112933 43
50	Contact frame		113165 3
51	Main frame		113324 30
52	Battery case		114623 3
53	Radiator coil		114624 3
54	Flexible Printed circuit for bulbs		114625 27
55	Spring plate		114626 2
56	Casing assembly		114627 68
57	Bag with accessories		114628 28
58	Modulholder-		114629 7
59	Roof top painted		114630 7
60	Engine-room window		114631 3
61	Headstock		114632 2
62	Uic wall outlet		114633 2
63	Step		114634 2
64	Ventilation ES grille		114635 3
65	Bogie frame 1 assembly		114636 25
66	Bogie frame 2 assembly		114637 25
67	Automatic vigilance device		114638 2
68	Spring block		114639 2
Variant Parts 63701			
69	Insulator		106553 3
70	Casing assembly		114640 68
71	Bag with accessories		114641 28
72	Roof top painted		114642 7
73	Engine-room window		114643 3
74	Uic wall outlet		114644 2
75	Step		114645 2
76	Ventilation ES grille		114646 3
~ AC Wechselstrom			
77	Locdecoder Motorola		10738 ---
78	Whisper wiper short		40064 ---
79	Traction tyre set 10 apiece		40075 ---
80	Wheelset with 2 traction tires		90834 20
81	Wheelset without Gear		90835 16
82	Wheelset without traction tyre		90836 18
83	Gear set		100623 6
84	Gear bottom for Collector		109114 6
85	Screw M 1,6x5		110008 2

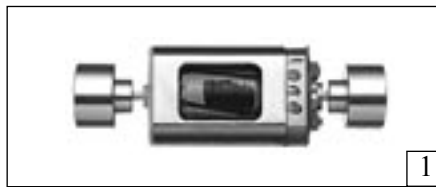

14 o. Abb. / no ill.
Kardanschale kurz
Cardan bearing short

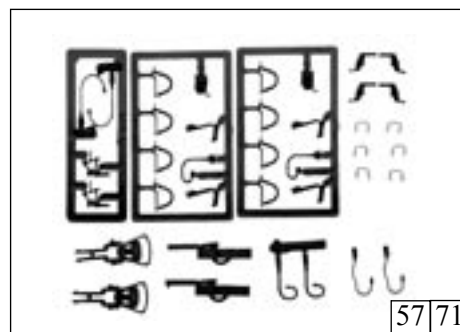
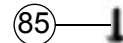
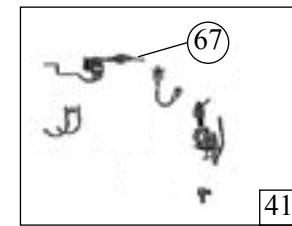
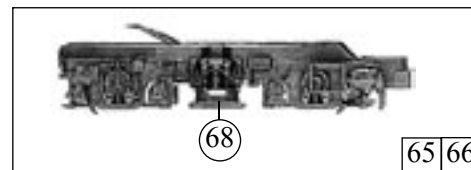
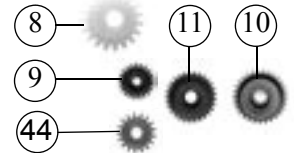
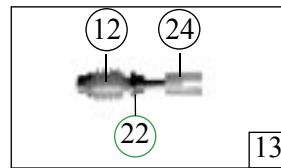
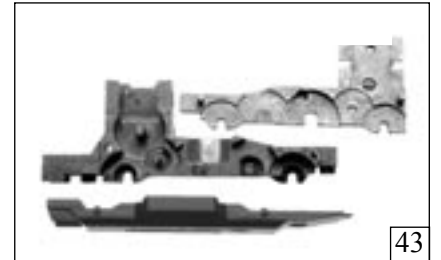
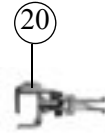
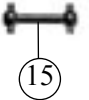

Ersatzteile erhalten Sie bei Ihrem Fachhändler, Ihrer Landesvertretung, oder bei:

You can order your Replacement Parts at your local dealer, your country representative, or:

Passez commande des pièces détachées chez votre détaillant, chez le S.A.V. de votre importateur national ou en direct au S.A.V. ROCO:

ROCO Modellspielwaren VertriebsgmbH & Co. Handels KG - Service -
Georg-Wrede-Straße 49
D-83395 Freilassing
 ☐ +49 / (0)86 54 / 47 63 0
 Fax: +49 / (0)86 54 / 47 63 50
 E-Mail: service@roco-online.de